

Need a product urgently?

CALL US: +65 6294 6388

EMAIL: cmltc@singnet.com.sg

VISIT US: 75 Rowell Road, Singapore 208011

OPENING HOURS: Monday-Friday, 9.00AM – 5.30PM

Why choose Chan Man Lee?

- ✓ Ready stock of 25,000 products
- ✓ No MOQ required for majority of our products
- ✓ Product pickup ready in 10 minutes~1 working day
- ✓ Certified/authorised distributor for over 30 brands
- ✓ Only supplies products from well-known, esteemed brands
- ✓ Only genuine, authentic, factory-original products
- ✓ Technical knowledge on product codes (IMPA, sizing, etc.)

ARMEG ™



PRODUCT GUIDE

THINK SMART  PERFORM SMART  TRUST ARMEG

 MADE IN SHEFFIELD

Trusted by Professionals for Over 40 Years



THINK SMART. PERFORM SMART. TRUST ARMEG

www.armeg.com

© 2018 Armeg

CONTENTS



Installation Innovations

	Page
EBS - Square Hole Drill	3
SBC - Solid Board Cutters & Accessories	5
Cable Guiding - Rod Sets	7
Cable Guiding - SDS Plus Drill Bits	9
AHC - Adjustable Hole Cutter & Accessories	11



Masonry - Drill Bits

	Page		Page
SDS Max Hammer Drill Bits	15	Professional Masonry Drill Bits	27
Qfds SDS Plus Hammer Drill Bits	19	Masonry Drill Bits	29
a-line SDS Plus Hammer Drill Bits	23	R1 Rebar Cutting Drills & Accessories	31
Twister Impact Rated 1/4" Hex Masonry Drill Bits	25		



Masonry - Core Drills & Accessories

	Page
Dry Diamond Core Drills	35
ProHD - Professional Heavy Duty Core Drills	39
HSM - High Speed Masonry Core Drills	43



Masonry - Chiselling & Accessories

	Page
SDS Max Points & Chisels	47
SDS Plus Channelling & Scutch Comb Chisels	49
SDS Plus Points & Chisels	51
Diamond Wall Chasing Blade	53



Wood - Drill Bits

	Page		Page
WoodBeaver Nail-Proof	57	Flat Wood Drill Bits & Accessories	63
WoodBeaver - Standard & Stubby	59	Brad Point Wood Drill Bits	65
Wood Auger Drill Bits	61		



Metal - Large Diameter Drilling

	Page		Page
LDX Metal - Carbide Tipped Holesaws & Accessories	69	CVP - Cobalt Vari-Pitch Holesaws	75
CIR Range - Pro-Step & Quick-Cone Drills	71	Bi-Metallic HSS Holesaws	77
Acceler8% - Sheet Steel Holesaws & Accessories	73	Holesaw Accessories	79
		16 Piece Twister Drilling Set	81



Metal - Drill Bits

	Page		Page
HSS Flute Ground 135° Split Point Drill Bits	85	Long Series HSS Roll-Forged Jobber	90
HSS Roll-Forged Jobber Drill Bits	87	HSS Blacksmith Drill Bits	91



Tile - Drill Bits & Accessories

	Page		Page
PTC - Diamond Crown Porcelain Tile Drills	95	Diamond Grit Tile Drills	103
PTC - Carbide Tipped Porcelain Tile Drill Bits	99	Soft Tile Drill Bits	105
PTC - Tile Drilling Accessories	101	Tile Cutting Diamond Blades	107



Hand Tools & Accessories

	Page		Page
SCREWDRIVING		TOOL TOTES & KITS	
Switch-Blade - Interchangeable VDE Screwdriving Range	111	Tool Totes	135
GripX ² VDE Insulated Screwdrivers	115	ACCESSORIES	
Twister - Screwdriver Bit Sets & Accessories	117	16oz Claw Hammer	137
HAND TOOLS		5m Tape Measure	139
VDE Diagonal Side Cutters (160 & 200mm)	121	Brick Line Runner	141
VDE Combination Pliers (200mm & Long Nose)	123	Wrenches - Jaw Dropper / Grip-Fast / Pipe Chamfering Tools	143
Cable Cutters	125	Screw Extractors	147
CIR Range - Accessories	127	SDS Plus Chuck Adaptors & Socket Drivers	149
SAWING & CUTTING			
EBS Board Saw	129		
Retractable Utility Knife & Spare Blades	131		
Hacksaws & Spare Blades	133		

Technical Icons

These icons will appear throughout our catalogue, turn to the back page of the catalogue for further descriptions





1973
K-Taper

1986
SDS Plus

1995
SDS Max

1999
EBS
Electrical
Box Sinker

2002
PTC
Tile Drills

2015
Screwdriving
by Armeg

TRUSTED BY PROFESSIONALS FOR OVER 40 YEARS

Here at Armeg, our philosophy is to bring smarter drills and tools to professionals; tools that are designed to save tradesmen time, money and deliver efficiencies through intelligent and innovative design features.

Power tool accessories are at our core and we've been manufacturing hammer drill bits at our Sheffield HQ since 1973. Over the years our range has grown and our extensive collection now spans from general purpose drill bits to Screwdrivers and Hand Tools, including products that have revolutionised the industry.

We understand that tool reliability and trusted on-site performance is essential so we ensure that product quality and manufacturing excellence is at the heart of everything we do. Striving for built-in quality we ensure our products are designed, developed and engineered to the highest standards with technically robust designs and top material specifications.

That's why we've been trusted by professionals for over 40 years.

Armeg literature from past and present

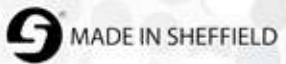

THINK SMART. PERFORM SMART. TRUST ARMEG

THINK SMART

Smarter & more efficient products

Designed to deliver efficiencies, saving tradesmen time and money through intelligent design features.

Application specific designs

Many products are purpose designed to meet specific job requirements providing a professional and technical solution.

In house design team

Dedicated R & D team focused on bringing new and smarter tools to the industry.

PERFORM SMART

Product Quality

Products are manufactured and engineered to the highest standards with technically robust designs and top material specifications.

Extensive Range

From general purpose drill bits to application problem solvers, many of our products are available in a variety of lengths, diameters and performance levels to meet different customer needs.

Reliability

Reliable products and trusted performance mean tradesmen can be confident that with Armeg they will always have the right tool for the job.

TRUST ARMEG

Made in Sheffield

40 years of experience, skills and knowledge built from manufacturing in Sheffield, world renowned as a centre of manufacturing excellence.

Product support

Professional and approachable customer service and technical support teams available to help with all enquiries from product recommendations to service queries.

Global suppliers

Ability to service requirements from around the world, on time and as required.

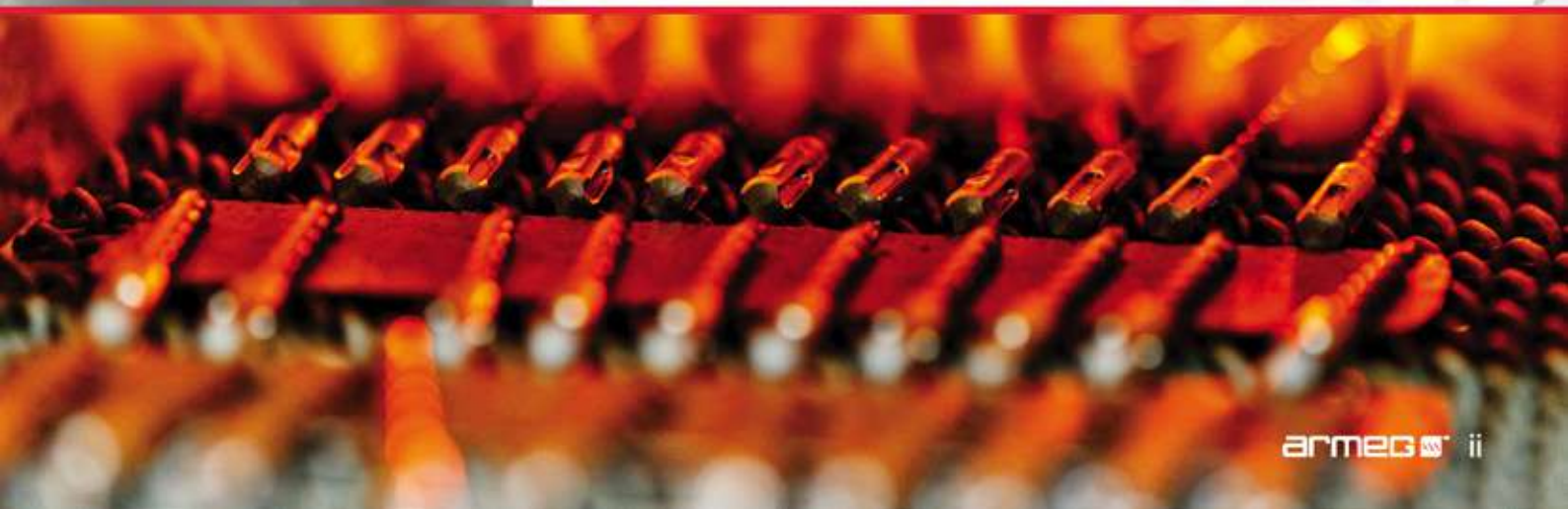

DEALER ZONE

At Armeg, we are proud to support our dealers with a range of support resources to help effectively promote and distribute our products. With an active sales force and customer service team, we have the flexibility to meet individual requirements and tailor our service.

Images

Access to an image library of our complete product range with product stills and action shots for web use, leaflets and promotional activity etc.

Video Clips



Video Clips for some of our most popular products are available on disc and online helping highlight key product features and benefits.

Technical Product Support

We have a dedicated Technical Support Team available to provide training on product applications, features, benefits and usage queries.

Literature

Product literature, catalogues and promotional flyers are available in hard copy and online PDF format to help create awareness and help sell through of products.

Merchandising POS displays

A wide choice of Armeg branded merchandising solutions are available ranging from POS signage to high impact display stands.

Product Samples

Access to product samples for sales teams is ideal for on-site visits and product demonstrations.

Dealer Referrals

If dealers stock it, we support it by referring users through to our stockists including online via our 'Find a Stockist' postcode search function.

Demand Creation Campaigns

Advertising campaigns, trade shows and many other marketing activities help us create and drive demand for our products.

Overnight Delivery Service

Rapid product despatch service and 'split delivery' options are available for urgent orders to ensure your customers receive their orders when they need them.

High Stock Levels

We carry high stock levels across our entire product range meaning we can keep up with changing fluctuations in demand.



ARMEG'S TWISTER BRAND FEATURES A WHOLE HOST OF IMPACT RATED DRILL BITS, SCREWDRIVER BITS AND ACCESSORIES, ALL SPECIFICALLY DESIGNED AND BUILT FOR USE IN IMPACT DRIVERS.

WOODBEEVER

The smoothest and fastest wood drill bits available with a nail-proof variety for nail embedded wood.

See Page 57



DRILL. WITH IMPACT.

Impact drivers aren't just great for driving screws, they're great for drilling too. The compact size of the machine makes it perfect for working in tight access areas, such as drilling between joists. Not to mention the fact it offers a one handed drilling solution, ideal for reach situations and reducing the risk of wrist-twist.



IT'S ALL ABOUT THE TORSION.

Impact drivers can deliver strong torsional force. When the impact driver faces enough resistance during drilling, the machine delivers fast and powerful torsional impacts, providing higher torque to help the tool keep drilling or driving.

NOT ALL 1/4" SHANKS ARE CREATED EQUAL.

Not all 1/4" shank accessories can withstand the higher torque produced by an impact driver. We only give our Twister Impact Rated seal of approval to tools which can offer the performance and durability required. All Twister products have the following in-built qualities:

- ✓ Strong materials
- ✓ Shock-resistant heat treatment process
- ✓ Designed to resist torsional impact
- ✓ International 1/4" shank standard ISO 1173:200
- ✓ Performance tested

ACCELER8%

Designed specifically for drilling sheet steel, Acceler8% is built for speed. See Page 73



TWISTER MASONRY

1 piece design made from high quality steel for optimum performance in impact drivers. See Page 25



15 PIECE MASONRY FIXING INSTALLATION SET

Featuring Twister impact rated screwdriver bits and drill bits, this is the perfect set for the professional tradesman using an impact driver. See Page 118



SCREWDRIVER BIT SETS

An impact rated range of smarter screwdriver bit sets & accessories. See Page 117



QUICK-CHANGE SDS PLUS TO 1/4" ADAPTOR

Perfect for converting Armeg Twister Impact rated accessories to SDS Plus compatibility for machine versatility. See Page 58



QUICK-CHANGE 1/4" EXTENSION ROD 230MM LONG

Quick-change easy grip collar provides rapid tool interchanges and is perfect for when extra reach is required. See Page 58



16 PIECE TWISTER DRILLING SET

Features Armeg's Impact rated premium quality drill bits, ideal for tradesmen using impact drivers. See Page 81





Page
3



EBS - Square Hole Drills

Drill a square hole in under 2 minutes

Page
5



SBC - Solid Board Cutters & Accessories

Drill easy fix access holes in solid boards in under a minute

Page
7



Cable Guiding - Rod Sets

Extreme tensile strength and user comfort when cable guiding

Page
9



Cable Guiding - SDS Plus Drill Bits

The one tool solution for guiding cables through cavity walls

Page
11



AHC - Adjustable Hole Cutter & Accessories

The flexible tool for creating down lighter holes

Material	EBS Tri-Cut	EBS Square	EBS Hard Material Chisel	Adjustable Hole Cutter	Cable Guide Drill Bit	SBC
Thermolite block	●	●	●	■	●	■
Medium density block (breeze)	●	●	●	■	●	■
Soft brick	●	●	●	■	●	■
Hard brick	●	■	●	■	■	■
Concrete	●	■	●	■	■	■
Plasterboard	■	■	■	●	■	■
Chipboard flooring	■	■	■	●	■	●
Plywood	■	■	■	●	■	■
Acrylic sheet	■	■	■	●	■	■

Product selector...

Simply choose the material you need to drill and use our rating guide to choose which is the best tool for you.

Armeg's Installation Innovations have been saving electricians and tradesmen thousands of hours for years. The original EBS Square Hole Drill is the centrepiece of our Installation Innovations range, brilliantly complimented by many other application specific tools. Whatever the domestic electricians requirements, we have smarter drilling and tooling solutions covered.

- Very suitable
- Suitable
- Suitable but better alternative
- Not suitable



Perfect for.....

**Drill a square hole for back boxes...
in under 2 minutes**

EBS Tri-Cut Round Cutter

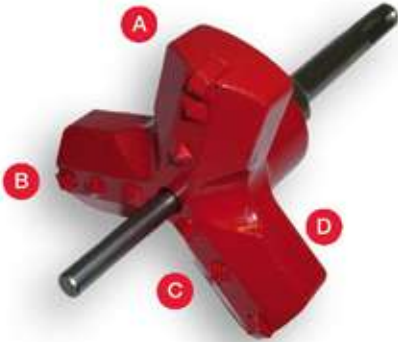

The recently upgraded Tri-Cut design is the ultimate design for drilling hard materials.

- A** Six 130° precision tungsten carbide inserts give a flatter back hole resulting in minimum movement of the back box and a neater finish
- B** 50% more tungsten carbide tips which are off-set for more efficient chiselling and better performance in hard materials
- C** Three precision cast high alloy wings result in a smoother drilling action and less kick back
- D** Unique Tri-Cut round cutter results in more even drilling and 20% reduced vibration

EBS can be used in:

- Common block & brick
- Hard bricks
- Wet / green masonry
- Uncured concrete
- (Please see EBS Technical Guide for further material recommendations)

EBS is ideal for occasions when:

- Time saving is essential
- Neat & professional finish is required
- Flat backed hole is desired
- Numerous back box holes need to be drilled

How to drill a square hole....



SDS drill bit for drilling pilot hole



Tri-Cut Round Cutter removes bulk of material and produces a flat back hole in the hardest materials



Square off using the rapid action Square cutter in softer materials



Square off using the Hard Material Chisel in harder materials



Single Back Box - Done!

Scan me for demo video



DID YOU KNOW?

The original 'Square Hole Drill' was a revelation when launched and has become the industry standard tool for sinking back boxes in masonry walls. Since then literally thousands of square holes have been drilled saving thousands of hours for electricians and tradesmen

DID YOU KNOW?

Our EBS System is designed and manufactured at our factory in Sheffield



It was first prototyped in 1998 at Armeg's Dronfield Manufacturing HQ and launched in 1999 with a 6 month full order book

EBS - Square Hole Drills

Description	Contents	Part Number	
Tri-Cut Single Box Sinking Set	1xEBS Tri-Cut Round Cutter c/w Dust Collection Unit 1xSquare Cutter c/w SDS Plus Drive Adaptor 1x80mm Wide EBS Hard Material Chisel 1x6.0mm SDS Plus Hammer Drill Bit	EBS.TC.SET	
Tri-Cut Complete Box Sinking & Channelling Set	1xEBS Tri-Cut Round Cutter c/w Dust Collection Unit 1xSquare Cutter c/w SDS Plus Drive Adaptor 1xDouble Square Cutter c/w SDS Plus Drive Adaptor 1xDouble Square Cutter Spacing Template 1x80mm Wide EBS Hard Material Chisel 1x30mm Channelling Chisel 5x6.0mm SDS Plus Hammer Drill Bit	EBS.TCINST.SET	
Tri-Cut Round Cutter c/w SDS Plus Drive Adaptor		EBS.ROUND.SET	
Square Cutter c/w SDS Plus Drive Adaptor		EBS.SQUARE.SET	
Double Square Cutter c/w SDS Plus Drive Adaptor		EBS.DOUBLE.BOX	
Double Square Cutter Spacing Template		RCEBSDBLTEMP	
SDS Plus Drive Adaptor (Designed for use with round cutter)		DL100B4IP	
SDS Plus Drive Adaptor (Designed for use with Round Cutter assembled with Dust Collection Unit)		EBS.DEXT.ADAPT	
SDS Plus Drive Adaptor (Designed for use with Square Cutter)		DL100B4IG	
SDS Plus Drive Adaptor (Designed for use with Double Square Cutter)		DL100B4IGDB	
Dust Collection Unit and Drive Adaptor - no cutter		EBS.DEXT.ASSY	



Minimum weight-2.3KG
Minimum impact energy -2.4 joules
Minimum wattage-850w



For optimum performance it is recommended to use a power tool with a min. drive power of 850w

TECH TIP!

All SDS shanks should be greased prior to and during use to prevent breakage caused by heat build-up

Have you tried?
EBS Board Saw



Perfect for cutting out square holes in plasterboard walls for the insertion of electrical back boxes See page 129

SBC COBALT

Perfect for.....

Drill easy fix access holes in solid boards in under a minute



Available in 111mm & 127mm sizes



111mm



127mm

A Depth Stop Ring

Precision manufactured depth-stop ring set to the same depth as the cap rebate makes it impossible to over-drill meaning the cap lies flush to the floor for a neat finish with 100% accuracy

B Rebating Cutters

Hardened steel rebating cutters produce a 6.5mm (1/4") rebate in the floor material creating a ledge for the SBC caps to precisely locate on in the flooring

C Cobalt Cutting Teeth

Tougher tooth design manufactured with M42 superior steel featuring 8% Cobalt provides excellent wear resistance properties at higher drilling temperatures. This gives extended tool life, and lasts at least 100% longer than standard bi-metallic holesaws

SBC can be used in:

- Flooring grade chip board up to 22mm thick

SBC is ideal when creating holes for:

- Running cables under floors for rewires / installations
- Access above downlighters during installation or maintenance
- Access when running pipework under flooring
- General work where access to the floor void under solid flooring is required

DID YOU KNOW?

SBC caps are removable allowing for repeat access into solid floors











Scan me for demo video



TECH TIP!

When using in waterproof boards, if it is required to maintain the waterproof integrity of the board, it is advisable to seal around the edges of the rebated cap with silicone sealant or similar

SBC - Solid Board Cutters & Accessories

Description	Contents	Part Number	
111mm Complete Set	1x111mm Cobalt Solid Board Cutter 3x111mm Plugs 1xHexagon Drive Adaptor for SBC Cutter 1xSDS Plus Drive Adaptor for SBC Cutter	SBC111SET	
111mm Plug Set	1x111mm Cobalt Solid Board Cutter 3x111mm Plugs	SBC PLUGSET	
111mm Plug x 1		RPSBC111PLUG	
111mm Plugs - pack of 10		SBC111PLUGX10	
127mm Complete Set	1x127mm Cobalt Solid Board Cutter 3x127mm Plugs 1xHexagon Drive Adaptor for SBC Cutter 1xSDS Plus Drive Adaptor for SBC Cutter	SBC127SET	
127mm Plug Set	1x127mm Cobalt Solid Board Cutter 3x127mm Plugs	SBC127PLUGSET	
127mm Plug x 1		RPSBC127PLUG	
127mm Plugs - pack of 10		SBC127PLUGX10	

Operation Speed Chart

Diameter Size mm	Recommended RPM
111mm	900
127mm	900

TECH TIP!

SBC can be used with standard holesaw adaptors with a 5/8" - 18 UNF thread.

Try the Hex Shank (part no. CHD32-64HEX) or the SDS Plus Shank (part no. CHD32-64SDS). See page 80.



When used with relevant adaptor



When used with relevant adaptor



Ideal machines will have: 850w Slipping Clutch



Perfect for.....
Extreme tensile strength and user comfort when cable guiding

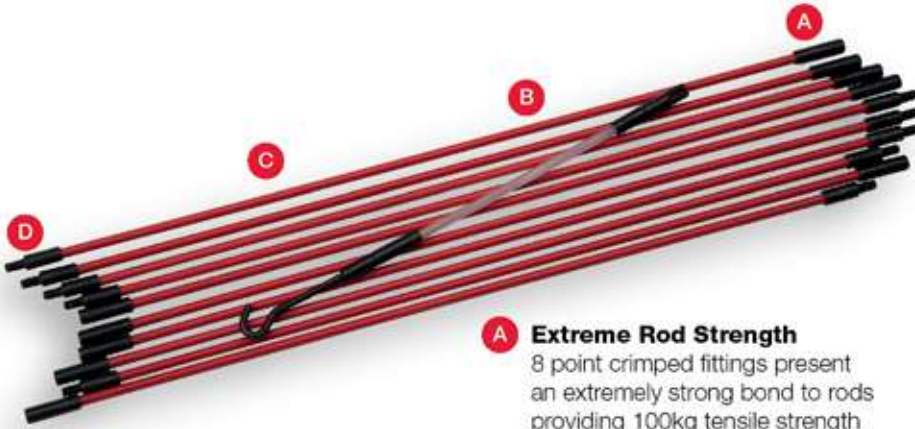

A Extreme Rod Strength

8 point crimped fittings present an extremely strong bond to rods providing 100kg tensile strength and increased durability

B Ultimate Smooth Finish

Designed for increased user comfort when routing, the rods have an anti-abrasive finish for a smoother touch

C Flexibility

4 4mm diameter rods provide extreme flexibility, perfect for pulling wires through acute and tight angles

D Slim Fit Design

6mm 'slim fit' designed fittings provide accessibility through smaller holes

Cable Guide Rods are ideal for:

- Routing cables through conduit, cavities, under floors, over suspended ceilings etc

Cable Guide Rods are great for applications such as:

- Domestic and industrial installation / maintenance
- Shop fitting
- Data cabling
- Alarm installation



DID YOU KNOW?

The 'mini' 330mm length rod set is the perfect size for fitting in your tool box

TECH TIP!

If a rod becomes snagged or trapped try:-

1. A gentle whipping or jumping motion
2. A 'push and pull' action
3. Rotating the rod – ensure it is rotated clockwise to prevent it becoming unscrewed



TECH TIP!

When connecting rods, ensure they are completely mated. There should be no visible gaps between the fittings

Scan me for demo video



Cable Guiding - Rod Sets

Description	Contents	Part Number	
10 x 1m Cable Guide Rod Set	Set contains 10 x 1m rods plus accessories 1 x nylon flexi, 1 x mini-eye, 1 x mini-hook	SBC.CR.SET 2	
10 x 300mm Cable Guide "Mini" Rod Set	Set contains 10 x 300mm rods plus accessories 1 x nylon flexi, 1 x mini-eye, 1 x mini-hook	SBC.CR.SET 4	



M4x0.7

Have you tried?
Cable Guide Drill Bit



Perfect for cavity or rubble
filled walls See page 9



Perfect for.....

The one tool solution for guiding cables through cavity walls



- A Premium Quality SDS Drill Bit**
Produced using our premium quality Sheffield manufactured Qfds drill bits for strength and durability
- B Precision Machined Cable Holes**
2.5mm diameter precision machined holes in the drill shank and drill tip allow cables to be connected to the drill bit and simply pushed or pulled through the cavity
- C Elongated Drive Slot**
Elongated drive slot enables the cable hole to be drilled at the products strongest point for durability. Cables also lie flat in the recessed slot meaning wire can be smoothly pulled through walls without snagging
- D 400mm / 600mm Length Design**
Specifically designed to either 400mm or 600mm length to enable access through a cavity wall

Cable Guide Drill Bits can be used in:

- Brick & block constructed walls
- (Not designed for engineering brick or concrete)
- Thick & stone walls (16mm dia)

Cable Guide Drill Bits are ideal for fitting cables including:

- TV Co-axial
- Telephone
- Electric / power
- Alarm system
- Data
- Large & multiple cable installation (16mm diameter)

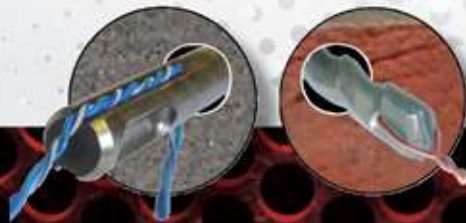

DID YOU KNOW?

Our Cable Guide Drill Bits are designed, tested, proved and produced at our Sheffield HQ



TECH TIP!

If routing cable by using the hole near the carbide tip, please be aware that after drilling this end of the drill could be hot and should be allowed to cool before handling

Scan me for demo video



Cable Guiding - SDS Plus Drill Bits

Description	Diameter Size mm	Overall Length mm	Working Length mm	Part Number
10mm x 400mm Cable Guide Drill Bit	10	400	310	CGS10.0X400
16mm x 600mm Cable Guide Drill Bit	16	600	510	CGS16.0X600



Recommended speed for Cable Guide Drill Bit is largely governed by the power tool itself. This is because the product is designed to be used in power tools where in the majority of cases there is no facility to regulate the speed (i.e. SDS Plus machines).



Have you tried?
Cable Guide Rods



Ideal when longer distances / thicker structures need to be traversed

See page 7

Perfect for.....
The flexible tool for creating
downlighter holes

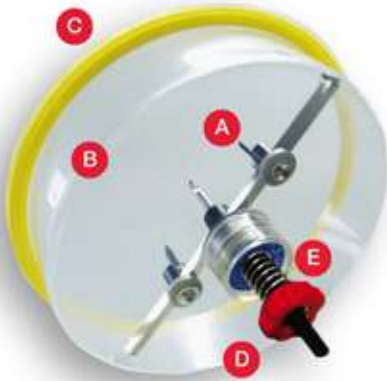

A 2 Adjustable HSS Cutting Blades

Adjustable cutting blades can be altered to cut a variety of diameters from 40 – 203mm for the ultimate flexibility. Also reduces the need to carry a holesaw for every size, making it the cost effective solution to creating large diameter holes

B Impact Resistant Dust Collection Unit

Provides protection from falling debris when drilling vertically upwards for added user comfort and a safer, hassle-free drilling experience

C Soft Grip Support Ring

Silicone support ring grips to the surface to prevent slippage when drilling for accurate and clean holes

D Depth Control Mechanism

The adjusting nut and compression spring mechanism provides depth control allowing you to reduce the drilling depth as required to avoid potential strikes with hidden objects

E Compression Spring

Compression spring absorbs vibration when cutting to provide a smoother drilling action

AHC is designed to cut:

- Veneer
- Plywood
- Wood board
- Plaster board
- Acrylic

AHC is ideal when creating large diameter holes for:

- Downlighters
- Fans
- Vents
- Speaker Apertures

DID YOU KNOW?

The AHC blades are set up so that they do not follow the same cutting path, one blade cuts the inside and one cuts the outside of the material to be removed. This provides a more balanced cutting action



TECH TIP!

Ensure blades contact material gradually to prevent shock loading and potential 'grab'

Scan me for demo video



**Perfect for.....
Enlarging existing holes for fitting
new downlighters**

Designed for use with the Adjustable Hole Cutter, twin stabilising bars centralize the tool within existing holes. The bars are adjusted to the outside diameters of existing holes, whilst the Adjustable Hole Cutters twin blades create precision holes at the new required diameter giving a neat and professional finish.

Cutting blades are adjusted to the required diameter of the new hole

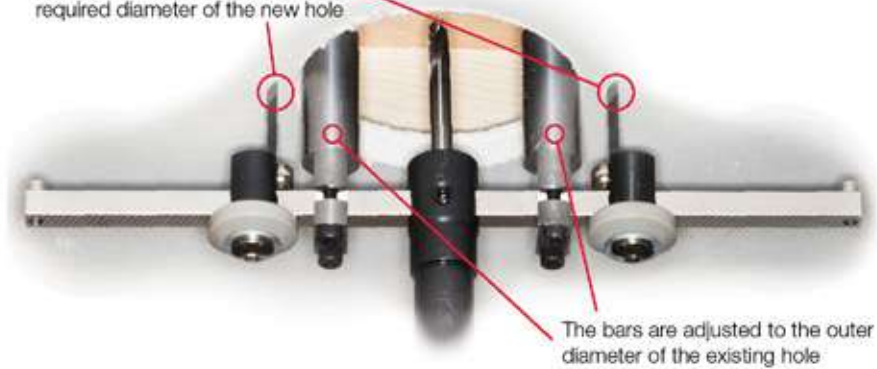

AHC - Adjustable Hole Cutter & Accessories

Description	Technical / Product Detail	Part Number	
Adjustable Hole Cutter (40mm - 200mm)	Operates from 40 - 203 mm	AHC40-200	
AHC Hole Enlargening Accessory	Pack contains two stabilising bars plus assembly instructions	AHC40-200HEA	
AHC spare blades twin-pack	Pack contains two spare blades	AHC40-200SB	
AHC spare 6mm pilot drill		AHC40-200PD	

Operation Speed Chart

Diameter Size mm	Speed RPM
40 - 49	800
50 - 69	600
70 - 89	400
90 - 119	200
120 - 203	100



Thickness of cut:
3mm - 25mm
(50mm when cut
from both sides)



Page
15



SDS Max Hammer Drill Bits Single Tip & Cross Head

The ultimate in accuracy of cut and cleanliness of breakout

Page
19



Qfds SDS Plus Hammer Drill Bits

The professional standard for multiple hole drilling in masonry using an SDS plus machine

Page
23



a-line SDS Plus Hammer Drill Bits

Value option for SDS Plus hammer drilling in masonry materials

Page
25



Twister Impact Rated 1/4" Hex Masonry Drill Bits

Designed for optimum performance in impact drivers

Page
27



Professional Masonry Drill Bits

Professional option for masonry drilling using a 3-Jaw Chuck Machine

Page
29



Masonry Drill Bits

Value option for occasional hole drilling in masonry using a 3-Jaw chuck Machine

Page
31



R1 Rebar Cutting Drills & Accessories

The problem solving solution for drilling in re-enforced concrete when hole location is fixed

Material	SDS Max	SDS Plus Qfds	SDS Plus a-line	Twister Masonry	Professional Masonry	Standard Masonry
Heavy Duty Concrete	●	●	■	■	●	■
General Concrete	●	●	●	■	●	●
Hard Bricks	●	●	■	■	●	■
Soft Bricks	●	●	●	●	●	●
Lightweight Blocks	●	●	●	●	●	●
Natural Stone	●	●	●	■	●	●
Constructional Granite	●	●	■	■	●	■
Limestone	●	●	●	■	●	●

Product selector...

Simply choose the material you need to drill and use our rating guide to choose which is the best tool for you.

Since 1973 Carbide Tipped hammer drill bits have been at the heart of our manufacturing heritage. Over the years our ranges have expanded and evolved leaving us in the enviable position of being the UK's only manufacturer of Carbide Tipped masonry and hammer drill bits. The SDS Qfds shank design is unique to Armeg and provides users with an easy-location option when inserting SDS Plus hammer drill bits in to chuck machines.

- Very suitable
- Suitable
- Suitable but better alternative
- Not suitable



Perfect for.....
Heavy duty, large diameter
and deep hole drilling

Manufactured to top industry standards at our factory in Sheffield, all our SDS Max feature:

- A** Precision machined shanks which operate in SDS Max machines and are manufactured to Bosch and PGM specifications
- B** European sourced high alloy steel to ensure strength and durability
- C** Automatically straightened on purpose made machines to 75% above PGM tolerance targets for a smoother drilling action with less machine stress
- D** Proven flute geometries which enable maximum spoil removal, speed and durability

SDS Max can be used in:

- Heavy duty concrete
- General concrete
- Hard bricks
- Soft bricks
- Lightweight blocks
- Natural stone
- Constructional granite
- Limestone

SDS Max are ideal when drilling holes for:

- Fixings and anchors
- Through holes for cables & wires
- Through holes for pipes
- Pilot holes for coring
- Property maintenance

DID YOU KNOW?

The longest SDS Max "special manufacture" drill bit ever made by Armeg was 1500mm long and needed plenty of pre-drilling with shorter drill bits!

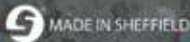

TECH TIP!

A little grease on the shank of the drill bit will reduce heat build-up and improve tool and power tool life

Scan me for demo video



Our SDS Max range offers two tip options for increased variety of choice

SDS Max Single Tip

The cost effective and faster solution for producing large diameter holes in masonry.



Hammer Grade Carbide Tip

Hammer grade tungsten carbide tip gives extended life in the hardest masonry materials

Copper Brazed to 1100°c

Furnace brazing process uses a copper braze heated to 1100°c giving the ultimate bond between body and tip, allowing the drill bit to withstand greater pressure and produce a greater number of holes

Precision Machining

Precision machining to accept the proven single tip design ensures optimum support behind seated tip for durability

Precise Tip Alignment

Tip insertion is secured using purpose made machines operating to pre-set specifications & tolerances, ensuring a consistently accurate and perfectly centralised tip for rounder holes

SDS Max Cross Head

The high quality solution for truer, rounder holes – ideal for precise technical fixing applications.

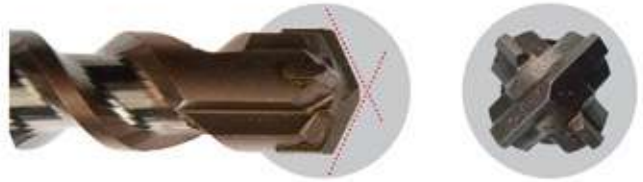

Cross Head Design

Unique Armeg Cross Head design ensures all 4 cutting edges work at the same time to provide a smoother drilling action

Carbide Side Tips

Purpose designed carbide side tips are complimentary cutters to the main carbide tip and help provide a more effective drilling action

Deep Clearways

Deep precision machined clearways in between carbide tips allow spoil to flow quickly away from the cutting edge, avoiding trapped material and providing longer tool life

Co-Planer Faceting

The 30° rake angle on the main carbide tip is matched by an identical 30° facet on the supporting steel. This allows spoil to flow along an uninterrupted path down the carbide edge for faster drilling and longer life

SDS Max Single Tip

Diameter Size mm	Overall Length mm	Working Length mm	Part Number
12	305	165	MX12.0X305S
12	390	250	MX12.0X390
12	540	400	MX12.0X540
13	390	250	MX13.0X390
14	305	165	MX14.0X305S
14	390	250	MX14.0X390
14	540	400	MX14.0X540
16	305	165	MX16.0X305S
16	450	310	MX16.0X450S
18	305	165	MX18.0X305S
18	450	310	MX18.0X450S
20	285	165	MX20.0X285S
20	430	310	MX20.0X430S
22	285	165	MX22.0X285S
22	430	310	MX22.0X430S
25	285	165	MX25.0X285S
25	430	310	MX25.0X430S



SDS Max Crosshead

Diameter Size mm	Overall Length mm	Working Length mm	Part Number
16	390	250	MX16.0X390
16	540	400	MX16.0X540
16	920	770	MX16.0X920
18	390	250	MX18.0X390
18	540	400	MX18.0X540
20	370	250	MX20.0X370
20	520	400	MX20.0X520
20	920	800	MX20.0X920
22	370	250	MX22.0X370
22	520	400	MX22.0X520
22	920	800	MX22.0X920
24	370	250	MX24.0X370
24	520	400	MX24.0X520
25	370	250	MX25.0X370
25	520	400	MX25.0X520
25	920	800	MX25.0X920
26	520	400	MX26.0X520
28	370	250	MX28.0X370
28	570	450	MX28.0X570
30	370	250	MX30.0X370
30	570	450	MX30.0X570
32	370	250	MX32.0X370
32	570	450	MX32.0X570
32	920	800	MX32.0X920
35	570	450	MX35.0X570
38	570	450	MX38.0X570
40	570	450	MX40.0X570



Recommended speed for SDS Max is largely governed by the power tool itself. This is because the product is designed to be used in power tools where in the majority of cases there is no facility to

regulate the speed (i.e. SDS Max machines). If used in a machine where speed regulation is possible, a general recommendation is the larger diameter of the drill bit being used, the slower the speed.



Have you tried?
**SDS Max to SDS Plus
 Quick Fit Adaptor**



*If small diameter holes under
 12mm diameter are required
 the adaptor is ideal*
 See page 42

Perfect for.....
The professional standard for multiple hole drilling in masonry materials using an SDS Plus Machine



Manufactured to top industry standards at our factory in Sheffield, all our SDS Plus feature:

A Unique Qfds Shank System 

The Armeg Quick Fit Drill Shank System gives almost instant location of the drill bit in the SDS machine. Widened entry profiles at the top of the SDS grooves enable huge improvements in ease and speed of location and reduction of machine chuck wear

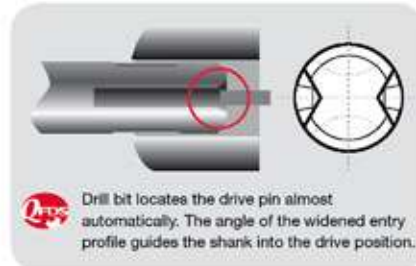

B European sourced high alloy steel to ensure strength and durability

C Proven flute geometries to enable maximum spoil removal, speed and penetration rates

D Automatically straightened on purpose made machines to 75% above PGM tolerance targets for a smoother drilling action with less machine stress

SDS Plus can be used in:

- Heavy duty concrete
- General concrete
- Hard bricks
- Soft bricks
- Lightweight blocks
- Natural stone
- Constructional granite
- Limestone

SDS Plus are ideal when drilling holes for:

- Fixings & anchors
- Through holes for cables & wires
- Through holes for pipes
- Pilot holes for coring
- Property maintenance

DID YOU KNOW?

Armeg is the UK's only SDS Plus manufacturing company and we have been making the drill bits since the late 1980's

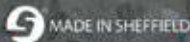

TECH TIP!

Always keep the drill bit shank properly lubricated with a machine manufacturers recommended grease

Scan me for demo video



Our SDS Plus range offers two tip options for increased variety of choice

SDS Plus Single Tip

The cost effective and faster solution for producing holes in masonry.



Hammer Grade Carbide Tip

Hammer grade tungsten carbide tip gives extended life in the hardest masonry materials

Copper Brazed to 1100°C

Furnace brazing process uses a copper braze heated to 1100°C giving the ultimate bond between body and tip, allowing the drill bit to withstand greater pressure and produce a greater number of holes

Precision Machining

Precision machining to accept the proven single tip design ensures optimum support behind seated tip for durability

Precise Tip Alignment

Tip insertion is secured using purpose made machines operating to pre-set specifications & tolerances, ensuring a consistently accurate and perfectly centralised tip for rounder holes

SDS Plus Cross Head

The high quality solution for truer, rounder holes and longer life – ideal for precise technical fixing applications.



Cross Head Design

Unique Armeg Cross Head design ensures all 4 cutting edges work at the same time to provide a smoother drilling action for truer, rounder holes

Carbide Side Tips

Purpose designed carbide side tips are complimentary cutters to the main carbide tip and help provide a more effective drilling action

Deep Clearways

Deep precision machined clearways in between carbide tips allow spoil to flow quickly away from the cutting edge, avoiding trapped material and providing longer tool life

Co-Planer Faceting

The 30° rake angle on the main carbide tip is matched by an identical 30° facet on the supporting steel. This allows spoil to flow along an uninterrupted path down the carbide edge for faster drilling and longer life

Qfds SDS Plus Hammer Drill Bits

Diameter Size mm	Overall Length mm	Working Length mm	Part Number
4.0	110	50	S04.0X110
4.0	160	100	S04.0X160
5.0	110	50	S05.0X110
5.0	160	100	S05.0X160
5.0	210	150	S05.0X210
5.5	110	50	S05.5X110
5.5	160	100	S05.5X160
5.5	210	150	S05.5X210
5.5	260	200	S05.5X260
6.0	110	50	S06.0X110
6.0	160	100	S06.0X160
6.0	210	150	S06.0X210
6.0	260	200	S06.0X260
6.0	450	400	S06.0X450
6.5	110	50	S06.5X110
6.5	160	100	S06.5X160
6.5	210	150	S06.5X210
6.5	250	200	S06.5X250
6.5	400	350	S06.5X400
7.0	110	50	S07.0X110
7.0	160	100	S07.0X160
7.0	210	150	S07.0X210
8.0	110	50	S08.0X110
8.0	160	100	S08.0X160
8.0	210	150	S08.0X210
8.0	260	200	S08.0X260
8.0	450	400	S08.0X450
8.0	600	550	S08.0X600
10.0	110	50	S10.0X110
10.0	160	100	S10.0X160
10.0	210	150	S10.0X210
10.0	260	200	S10.0X260
10.0	310	250	S10.0X310
10.0	450	400	S10.0X450
10.0	600	550	S10.0X600
10.0	1000	950	S10.0X1000



Diameter Size mm	Overall Length mm	Working Length mm	Part Number
11.0	310	250	S11.0X310
12.0	160	100	S12.0X160
12.0	210	150	S12.0X210
12.0	250	200	S12.0X250
12.0	300	250	S12.0X300
12.0	450	400	S12.0X450
12.0	600	550	S12.0X600
12.0	1000	950	S12.0X1000
13.0	250	200	S13.0X250
13.0	450	400	S13.0X450
14.0	150	100	S14.0X150
14.0	200	150	S14.0X200
14.0	250	200	S14.0X250
14.0	300	250	S14.0X300
14.0	450	400	S14.0X450
14.0	600	550	S14.0X600
14.0	1000	950	S14.0X1000
15.0	250	200	S15.0X250
16.0	150	100	S16.0X150
16.0	200	150	S16.0X200
16.0	250	200	S16.0X250
16.0	300	250	S16.0X300
16.0	450	400	S16.0X450
16.0	600	550	S16.0X600
16.0	1000	950	S16.0X1000
18.0	200	150	S18.0X200
18.0	250	200	S18.0X250
18.0	300	250	S18.0X300
18.0	450	400	S18.0X450
18.0	600	550	S18.0X600
18.0	1000	950	S18.0X1000



Qfds SDS Plus Hammer Drill Bits

Diameter Size mm	Overall Length mm	Working Length mm	Part Number
20.0	200	150	S20.0X200
20.0	250	200	S20.0X250
20.0	300	250	S20.0X300
20.0	450	400	S20.0X450
20.0	600	550	S20.0X600
20.0	1000	950	S20.0X1000
22.0	250	200	S22.0X250
22.0	450	400	S22.0X450
22.0	600	550	S22.0X600
22.0	1000	950	S22.0X1000
24.0	250	200	S24.0X250
24.0	450	400	S24.0X450
25.0	250	200	S25.0X250
25.0	450	400	S25.0X450
25.0	600	550	S25.0X600
25.0	1000	950	S25.0X1000
26.0	450	400	S26.0X450
28.0	450	400	S28.0X450
30.0	450	400	S30.0X450



SDS Plus 5 Piece Set - Single Tip

Contents	Part Number
5.5 / 6.0 / 7.0 / 8.0 / 10.0 x 160mm Overall Length	SMP160



SDS Plus Hammer Drill Bits - Cross Head Design

Diameter Size mm	Overall Length mm	Working Length mm	Part Number
16.0	250	200	9SX16.0X250
16.0	450	400	9SX16.0X450
18.0	250	200	9SX18.0X250
18.0	450	400	9SX18.0X450
20.0	250	200	9SX20.0X250
20.0	450	400	9SX20.0X450
22.0	250	200	9SX22.0X250
22.0	450	400	9SX22.0X450
24.0	250	200	9SX24.0X250
24.0	450	400	9SX24.0X450
25.0	250	200	9SX25.0X250
25.0	450	400	9SX25.0X450
28.0	250	200	9SX28.0X250
28.0	450	400	9SX28.0X450



Recommended speed for SDS Plus is largely governed by the power tool itself. This is because the product is designed to be used in power tools where in the majority of cases there is no facility to

regulate the speed (i.e. SDS Plus machines). If used in a machine where speed regulation is possible, a general recommendation is the larger diameter of the drill bit being used, the slower the speed.



When used with relevant adaptor – QFMX

Have you tried?
SDS Max



Provides a heavy duty option for diameters over 12mm

See page 15



Perfect for.....

A great value option for SDS Plus hammer drilling in masonry materials



- A Straightness Checking**
100% straightness checking ensures products are 'true' to minimise wobble whilst drilling enhancing user comfort and ease of use
- B High Alloy Steel**
High alloy content steel is heat treated to hammer drill-bit standards to avoid bending or snapping under repeated drilling
- C Strong Product Finish**
Blasted and oiled product finish relieves stress points and provides a rust free product
- D Tungsten Carbide Tips**
Ultra hard tungsten carbide tips resist the abrasive action of hammering on masonry materials for extended product durability
- E Tip Centrality**
Tip centrality quality checks ensure that holes produced are rounder for a more secure fixing fit

a-line SDS Plus can be used in:

- General concrete
- Hard bricks
- Soft bricks
- Lightweight blocks
- Natural stone
- Constructional granite
- Limestone

a-line SDS Plus are ideal when drilling holes for:

- Fixings & anchors
- Through holes for cables & wires
- Through holes for pipes
- Pilot holes for coring
- Property maintenance



DID YOU KNOW?

The use of a-line branding was introduced by Armeg to differentiate the product from the premium Qids range, but provide the quality assurance of a standard Armeg product

TECH TIP!

Always keep the drill bit shank properly lubricated with a machine manufacturers recommended grease

a-line SDS Plus Drill Bits

Diameter Size mm	Overall Length mm	Working Length mm	Part Number
5.0	110	50	ALS05.0X110
5.0	160	100	ALS05.0X160
5.0	210	150	ALS05.0X210
5.5	110	50	ALS05.5X110
5.5	160	100	ALS05.5X160
5.5	210	150	ALS05.5X210
5.5	260	200	ALS05.5X260
6.0	110	50	ALS06.0X110
6.0	160	100	ALS06.0X160
6.0	210	150	ALS06.0X210
6.0	260	200	ALS06.0X260
6.5	160	100	ALS06.5X160
6.5	210	150	ALS06.5X210
6.5	260	200	ALS06.5X260
7.0	110	50	ALS07.0X110
7.0	160	100	ALS07.0X160
7.0	210	150	ALS07.0X210
8.0	110	50	ALS08.0X110
8.0	160	100	ALS08.0X160
8.0	210	150	ALS08.0X210
8.0	260	200	ALS08.0X260
8.0	450	400	ALS08.0X450



Diameter Size mm	Overall Length mm	Working Length mm	Part Number
10.0	160	100	ALS10.0X160
10.0	210	150	ALS10.0X210
10.0	260	200	ALS10.0X260
10.0	310	250	ALS10.0X310
10.0	450	400	ALS10.0X450
12.0	160	100	ALS12.0X160
12.0	210	150	ALS12.0X210
12.0	260	200	ALS12.0X260
12.0	310	250	ALS12.0X310
12.0	450	400	ALS12.0X450
14.0	210	150	ALS14.0X210
14.0	260	200	ALS14.0X260
14.0	310	250	ALS14.0X310
14.0	450	400	ALS14.0X450
16.0	210	150	ALS16.0X210
16.0	260	200	ALS16.0X260
16.0	310	250	ALS16.0X310
16.0	450	400	ALS16.0X450
18.0	210	150	ALS18.0X210
18.0	260	200	ALS18.0X260
18.0	310	250	ALS18.0X310
18.0	450	400	ALS18.0X450
20.0	210	150	ALS20.0X210
20.0	260	200	ALS20.0X260
20.0	310	250	ALS20.0X310
20.0	450	400	ALS20.0X450
25.0	450	400	ALS25.0X450



Recommended speed for a-line SDS Plus is largely governed by the power tool itself. This is because the product is designed to be used in power tools where in the majority of cases there is no facility

to regulate the speed (i.e. SDS Plus machines). If used in a machine where speed regulation is possible, a general recommendation is the larger diameter of the drill bit being used, the slower the speed.



When used with relevant adaptor – QFMX

Have you tried?
Qfds SDS Plus Hammer Drill Bits



Offers a premium alternative when SDS Plus Drilling



Perfect for.....
Designed for optimum performance in impact drivers

- A 1/4" Quick-Change Shank**
 Drill bits can be rapidly interchanged within power tools (including impact drivers) for convenient and hassle free drilling.
- B High Quality alloy Steel**
 Provides durability and strength for the drill bit to withstand the torsional impact of an impact driver.
- C 1 Piece Body Construction**
 Ensures concentricity of the drill bit during the drilling process for more accurate holes and a secure fixing fit.
- D Copper brazed at 1100°C**
 Furnace brazing process uses a copper braze at 1100°C giving the ultimate bond between body and tip, allowing the drill bit to perform longer and produce a greater number of holes.

- E Custom-Ground Drill Tip**
 Designed specifically for rotary only drilling, the custom-ground drill tip reduces the torque placed on the drill bit resulting in faster and more efficient drilling in impact drivers.

Twister Masonry Drills can be used in:

- Soft Brick
- Medium density block
- Concrete common bricks
- Red facing bricks
- Timber
- Plastic
- Sheet Metal
- Ceramic
- Soft Tile
- Not designed for use in heavy duty masonry materials

DID YOU KNOW?

Our new Twister Impact Rated masonry drills are designed and manufactured at our factory in Sheffield



Twister Masonry Drills are ideal for:

- Drilling fixings holes for wall plugs etc
- One handed drilling in tight spaces with an impact driver
- Drilling multiple materials with one drill bit and one power tool

TECH TIP!

Twister Masonry Drills perform best in an impact driver when free rotating rather than when the power tool is ratcheting. Ratcheting can be minimised by reducing pressure and withdrawing the drill bit from the hole periodically

Twister Impact Rated 1/4" Hex Masonry Drill Bits

Diameter Size mm	Overall Length mm	Working Length mm	Singles	Part Number Twin Pack	Packs of 4
5.5	150	95	-	TM05.5X150TP	TM05.5X150FP
6.0	150	95	-	TM06.0X150TP	-
7.0	150	95	-	TM07.0X150TP	-
8.0	150	95	TM08.0X150S	-	-
10.0	150	95	TM10.0X150S	-	-



**Twister Impact Rated
Masonry Drill Bit**



Granite Grind
Designed for rotary only drilling
under torsional impact

**Professional Masonry
Drill Bit**



No Grind
Designed for percussion & hammer drilling



Have you tried?
Masonry Fixing Installation Set



An Impact rated set featuring the most popular sizes of Twister Masonry Drill Bits & Twister Screwdriver Bits See page 118

Perfect for...
The professional option for masonry drilling using a 3 Jaw Chuck Machine



- A Straight Shank Design**
 Straight shank design manufactured to PGM standards for a secure fit into 3 Jaw Chucks
- B High Quality Steel**
 European sourced high alloy steel ensures strength and durability
- C Proven Flute Geometries**
 Proven flute geometries enable maximum spoil removal, speed and penetration rates
- D Copper Brazed to 1100°C**
 Furnace brazing process uses a copper braze to 1100°C giving the ultimate bond between body and tip, allowing the drill bit to withstand greater pressure and produce a greater number of holes
- E Percussion Grade Carbide Tip**
 Tip is specially designed with sharper angles specifically for percussive drilling, providing extended life in masonry materials

Professional Masonry Drills can be used in:

- Heavy duty concrete
- General concrete
- Hard bricks
- Soft bricks
- Lightweight blocks
- Natural stone
- Constructional granite
- Limestone

Professional Masonry Drills are ideal when drilling:

- Fixings & anchors
- Through holes for cables & wires
- Through holes for pipes
- Pilot holes for coring
- Property maintenance

DID YOU KNOW?

Armeg Professional Masonry drills have been produced since the company's formation in 1973

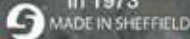

TECH TIP!

Always use on percussion-mode for a faster drilling action

Professional Masonry Drill Bits

Diameter Size mm	Overall Length mm	Working Length mm	Part Number
5.0	150	85	P05.0X150
5.5	150	85	P05.5X150
6.0	150	85	P06.0X150
6.5	150	85	P06.5X150
7.0	150	85	P07.0X150
8.0	150	85	P08.0X150
8.0	200	135	P08.0X200
10.0	150	85	P10.0X150
10.0	200	135	P10.0X200
12.0	150	90	P12.0X150
12.0	200	135	P12.0X200
13.0	150	90	P13.0X150
14.0	150	90	P14.0X150
16.0	150	90	P16.0X150
20.0	160	100	P20.0X160



With impact / Percussion function



When used with relevant adaptor and 3 Jaw Chuck

Have you tried?
Qfds SDS Plus Hammer Drills



Provide a significant step-up in drilling performance in respect of speed of drilling action See page 19

Perfect for...
A value option for occasional hole drilling in masonry using a 3 Jaw Chuck



- A** Product Diameter marking for easy tool identification
- B** Bright silver finish with rust proof properties
- C** Roll forged flutes rapidly evacuate spoil for progressive drilling action
- D** Ground facet angles to aid spoil removal
- E** Percussion grade tip for use in soft masonry materials

Standard Masonry Drills can be used in:

- General concrete
- Soft bricks
- Lightweight blocks
- Natural stone
- Limestone

Standard Masonry are ideal for drilling:

- Fixings & anchors
- Through holes for cables & wires
- Through holes for pipes
- Pilot holes for coring
- Property maintenance

DID YOU KNOW?

With the introduction of the Standard Masonry Drill Range, Armeg was then able to provide a 'Better and Best' option to users and dealers

TECH TIP!

Always use on percussion-mode for a faster drilling action

Masonry Drill Bits

Diameter Size mm	Overall Length mm	Working Length mm	Part Number
4.0	75	50	PZ04.0X075
5.0	85	50	PZ05.0X085
5.0	150	90	PZ05.0X150
5.5	85	50	PZ05.5X085
5.5	150	90	PZ05.5X150
6.0	100	60	PZ06.0X100
6.0	150	90	PZ06.0X150
6.5	100	60	PZ06.5X100
6.5	150	90	PZ06.5X150
7.0	100	60	PZ07.0X100
7.0	150	90	PZ07.0X150
8.0	120	75	PZ08.0X120
8.0	150	90	PZ08.0X150
10.0	120	75	PZ10.0X120
10.0	150	90	PZ10.0X150
10.0	200	125	PZ10.0X200
12.0	150	90	PZ12.0X150
12.0	200	125	PZ12.0X200
14.0	150	90	PZ14.0X150
16.0	150	90	PZ16.0X150



With impact / Percussion function



When used with relevant adaptor and 3 Jaw Chuck

Have you tried?
Professional Masonry Drills



Offer a high quality alternative with increased life, durability & speed See page 27



Perfect for...
Drilling in reinforced concrete when hole location is fixed



- A Precision Machined Clearways**
Provides a clear route for spoil evacuation, allowing Rebar to cut fresh material for longer tool life
- B Water Cooling System**
Hollow body design enables the use of a water cooling system which flushes away excess spoil and cools the drilling head for increased tool life.
- C Broad Cutting Head**
Purpose designed cutting head is broader than the tool body. Creates clearance as the tool progresses to avoid binding and jamming in the hole
- D Machined Spanner Flats**
Machined spanner flats on Rebar Cutter and accessories aid quick and easy disconnection of the system
- E Carbide Tipped Cutter**
Ultra hard wear resistant carbide tips provide tool durability
- F Tri-Ground Geometry**
Carbide tips are purposely manufactured with three sharp precision grinds designed to rapidly cut through steel rebar

Rebar can be used in:

- Reinforcing steel bar

Rebar is ideal for:

- A problem solving solution for drilling through reinforced concrete when the hole location is fixed



DID YOU KNOW?

Rebar cutters are

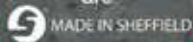

TECH TIP!



Always ensure Rebar Drill Bits are water cooled – use Armeg's water cooling system (PTCWFKIT)

R1 Rebar Cutting Drill Bits & Accessories

Diameter Size mm	Overall Length mm	Working Length mm	Part Number
16	100	65	CR16
18	100	65	CR18
20	100	65	CR20
25	100	65	CR25



Description	Diameter Size mm	Overall Length mm	Working Length mm	Part Number
Extension rod for drive adaptor	16	220	210	CREXT
SDS Plus drive adaptor for rebar cutters	SDS Plus drive shank	-	-	CRSDSAD
Water Feed Pressure Pump	-	-	-	PTCWFKIT

Recommended speed for Rebar is largely governed by the power tool itself. This is because it is designed to be used in power tools where in the majority of cases there is no facility to regulate the

speed. If used in a machine where speed regulation is possible, a general recommendation is the larger diameter of the drill bit being used, the slower the speed.



16 – 25mm Rebar Cutters ½" U.N.F



CRSDSAD ½" U.N.F



'Rotary Only' function with no impact



When used with relevant adaptor OFMX 'Rotary Only' function with no impact



Page
35



Dry Diamond Core Drills

The ultimate in accuracy of cut and cleanliness of breakout

Page
39



ProHD - Professional Heavy Duty Core Drills

Durability in the toughest concrete and masonry materials

Page
43



HSM - High Speed Masonry Core Drills

The rapid action core drill range

Material	Deep Core Drilling	Standard Length Drilling	
	Dry Diamond Core Drills	Professional Heavy Duty Core Drills	High Speed Masonry Core Drills
Heavy Duty Concrete	■	●	●
General Concrete	●	●	●
Hard Bricks	■	●	●
Soft Bricks	●	●	●
Lightweight Blocks	●	●	●
Natural Stone	●	●	●
Constructional Granite	■	●	●
Limestone	●	●	●

Product selector...

Simply choose the material you need to drill and use our rating guide to choose which is the best tool for you.

The Armeg Masonry Core drilling range offers the most comprehensive choice of masonry core drills available. With diameter options from 22mm to 152mm and drilling depths ranging from 60mm to 300mm, it is a hugely versatile range. All masonry materials can be drilled from soft blocks right through to concrete and engineering brick.

- Very suitable
- Suitable
- Suitable but better alternative
- Not suitable

Perfect for.....
The ultimate in accuracy of cut
and cleanliness of breakout



- A Dust Relief Slots**
This feature helps the dust escape and not become trapped in between the barrel and material which will improve performance
- B 130mm Throat**
Designed for deep core drilling, with the ability to core through a standard brick in one action – no need to stop and break out the core
- C Optimum Segment Configuration**
The segments sit in balance with the body and give relief internally and externally. This results in smoother and more accurate cutting and helps material core removal
- D Laser Welded Diamond Segments**
Each segment is laser welded to the end of the barrel rather than being brazed as is the practice with standard products. This creates a stronger bond between tip and barrel resulting in increased core durability in extreme drilling conditions
- E Increased Segment Height – 9mm**
Industry standard segments can be as low as 7mm. The Armeg Dry Diamond Cores are designed with 9mm segments to increase product life
- F High Concentration of Diamond Grit**
Premium synthetic diamond grit is used within the segment structure, allowing the Cores to be used on 'rotary only' for cleaner exit holes, improved performance and product life

Dry Diamond Core Drills can be used in:

- General concrete
- Soft bricks
- Lightweight blocks
- Natural stone
- Limestone
- Ideally suited to lightweight building materials, ordinary facing brickwork and blockwork up to 10n/mm²



DID YOU KNOW?

The diamond in our Dry Diamond Core Drills is made with manufactured industrial grade diamond pieces

Dry Diamond Core Drills are perfect for drilling holes designed for:

- Waste pipes
- Water feed pipes
- Cable entry / exit
- Flue passage
- Extractor fans
- Exhausts
- Dust extractor ducting

TECH TIP!

It is advisable to drill a pilot hole first with a masonry bit and then core using a guide rod assembled in the adaptor

Scan me for demo video



Dry Diamond Core Drills

Diameter Size mm	Overall Length mm	Working Length mm	Part Number
22*	345	300	CDD022LS
28*	345	300	CDD028LS
38	150	130	CDD038
48	150	130	CDD048
52	150	130	CDD052
65	150	130	CDD065
78	150	130	CDD078
107	150	130	CDD107
117	150	130	CDD117
127	150	130	CDD127
152	150	130	CDD152



5 Piece Set

Description	Set Contents	Part Number
5 Piece Dry Diamond Core Drill Set	42 / 52 / 65 / 117 / 127mm Cores SDS Plus to 1/2" BSP Adaptor, Hexagon to 1/2" BSP Adaptor, 200mm 1/2" BSP extension, 400mm masonry pilot drill, 225mm A-Taper Guide Rod, Extractor Drift	CDD5PCSET



Dry Diamond Cores Operation Speed Chart

Dimension Size mm	Recommended Running Speed (RPM)
38	1760
52	1280
107	625
152	440

*Please visit www.armeg.co.uk for full operation speed chart

TECH TIP!

Turn over for our full range of Dry Diamond Core Drilling Accessories



1/2" B.S.P



When used with relevant adaptor 22 – 78mm diameter cores only



For optimum performance it is recommended to use a power tool with a min. drive power of 850w



22mm and 28mm diameter cores have a hexagon shank and cannot be extended.

Perfect for.....
A comprehensive range of 1/2" BSP accessories for Dry Diamond Core Drills

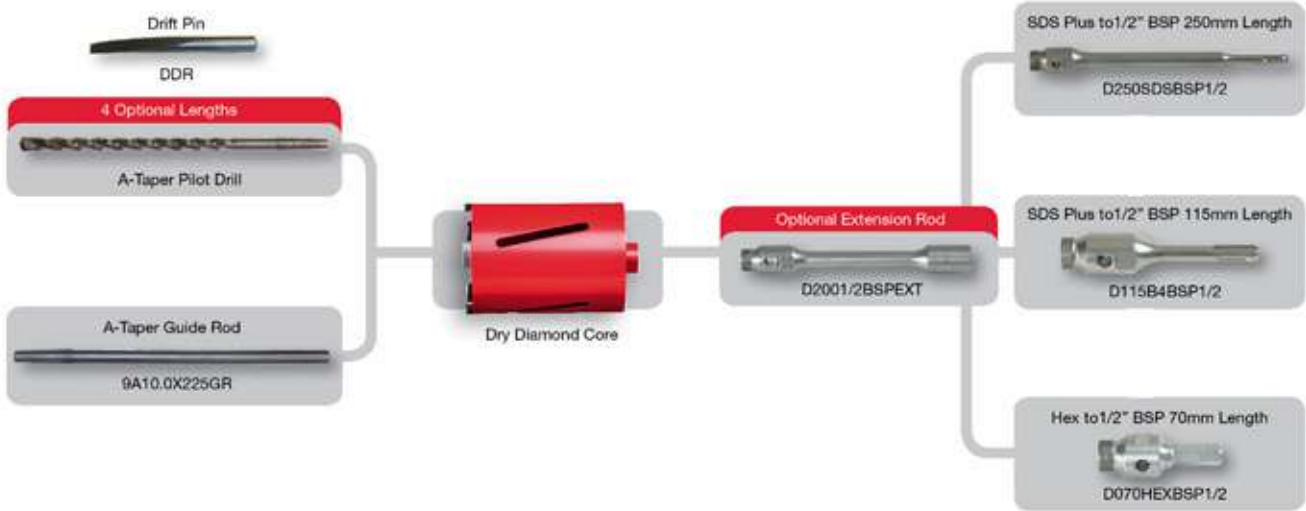



DID YOU KNOW?

Our 1/2" BSP accessories are  **MADE IN SHEFFIELD** with high quality steel for durability

TECH TIP!

Our 1/2" BSP Accessories are compatible with all 1/2" BSP threaded core drills

Dry Diamond Core Drill Accessories

Diameter Size mm	Overall Length mm	Working Length mm	Part Number	
10mm A-Taper guide rod	225	-	9A10.0X225GR	
10mm A-Taper pilot drill	225	-	A10.0X225QS	
10mm A-Taper pilot drill	300	-	A10.0X300QS	
10mm A-Taper pilot drill	400	-	A10.0X400QS	
13mm A-Taper pilot drill	250	-	A13.0X250	

Description	Shank Type	Thread Type	Working Length mm	Part Number	
Hex to 1/2" BSP Adaptor - 70mm long	10mm Hexagon	1/2" BSP	70	D070HEXBSP1/2	
SDS Plus to 1/2" BSP Adaptor 115mm long	SDS Plus	1/2" BSP	115	D115B4BSP1/2	
SDS Plus to 1/2" BSP Adaptor 250mm long	SDS Plus	1/2" BSP	250	D250SDSBSP1/2	
1/2 BSP to 1/2 BSP Extension - 200mm long	1/2" BSP (f)	1/2" BSP	200	D2001/2BSPEXT	
Extractor Drift	-	-	-	DDR	



10mm



1/2" B.S.P



For optimum performance it is recommended to use a power tool with a min. drive power of 850w

Perfect for.....
Durability & reliability in the toughest concrete and masonry materials



A Tapered Drive Design
 Tapered drive design system provides an easy connection system to adaptors, extensions and pilots. Supports the ability to switch machines, core diameters, lengths etc to exactly match user requirements

B Scrolled Flute
 Scrolled flute rapidly removes trapped spoil allowing the core to consistently drill fresh material for faster speeds and extended life. Reduces the need to regularly remove the drill whilst drilling

C Heavy Duty Wall
 Manufactured from solid steel stock, ProHD Cores feature a 4mm thick heavy duty wall which provides the perfect balance between durability and speed

D Tungsten Carbide Teeth
 Chisel action tungsten carbide teeth are designed to rapidly progress through the toughest masonry materials for the ultimate problem solving core drill

E Solid Flat Tooth Profile
 Purpose designed tooth angle allows the teeth to rapidly rip away masonry for fast drilling speeds

Professional Heavy Duty Cores can be used in:

- Heavy duty concrete
- General concrete
- Hard bricks
- Soft bricks
- Lightweight blocks
- Natural stone
- Constructional granite
- Limestone

DID YOU KNOW?

Armeg has been making ProHD cores since its formation in 1973 with the products being reliably trusted throughout the world

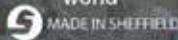

Professional Heavy Duty Cores are ideal when working on:

- Waste pipes
- Water feed pipes
- Cable entry / exit
- Flue passage
- Extractor fans
- Exhausts
- Dust extractor ducting

TECH TIP!

ProHD cores can be re-tipped as long as there is not too much damage to the core drill wall

Scan me for demo video



ProHD - Professional Heavy Duty Core Drills

Diameter Size mm	Overall Length mm	Working Length mm	Part Number
35	100	70	C035
40	100	70	C040
45	100	70	C045
50	100	70	C050
55	100	70	C055
65	100	70	C065
75	100	70	C075
80	100	70	C080
100	100	70	C100
115	100	70	C115
125	100	70	C125



Recommended speed for these cores is largely governed by the power tool itself. This is because they are designed to be used in power tools where in the majority of cases there is no facility to regulate the speed (SDS Plus, SDS Max machines etc.).

If used in a machine where speed regulation is possible, a general recommendation is the larger diameter of the core drill being used, the slower the speed.

TECH TIP!

Turn over for connection diagram



When used with the relevant adaptor



When used with the relevant adaptor



Coring can be carried out in 'rotary and impact' mode or 'rotary only' mode



Various Direct Drive machines (when used with relevant drill holder and 'K' Taper Adaptor) – please see part number table

Have you tried?

High Speed Masonry Cores



On lighter masonry materials such as block and brick work, the HSM core drills are ideal
See page 43

Taper Drive

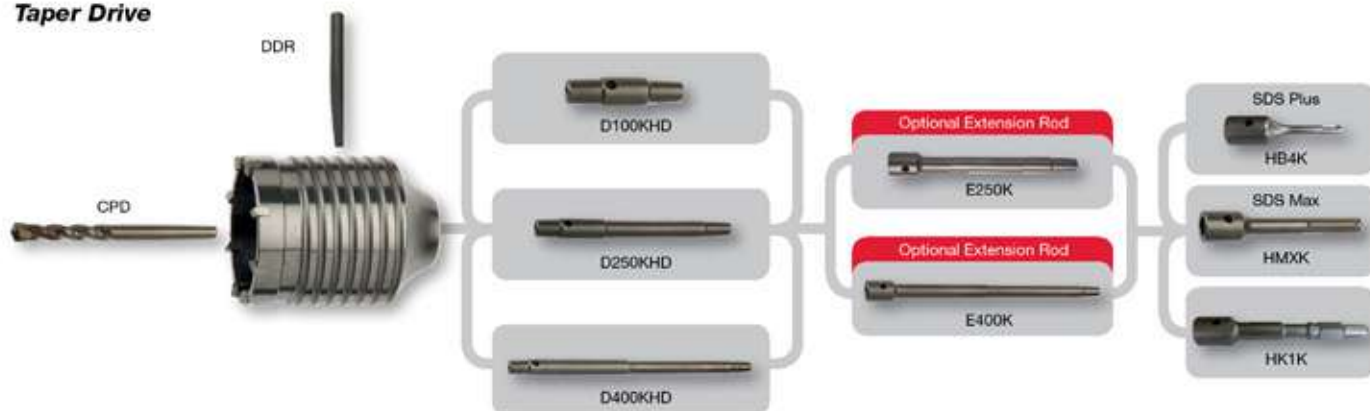

Direct Drive

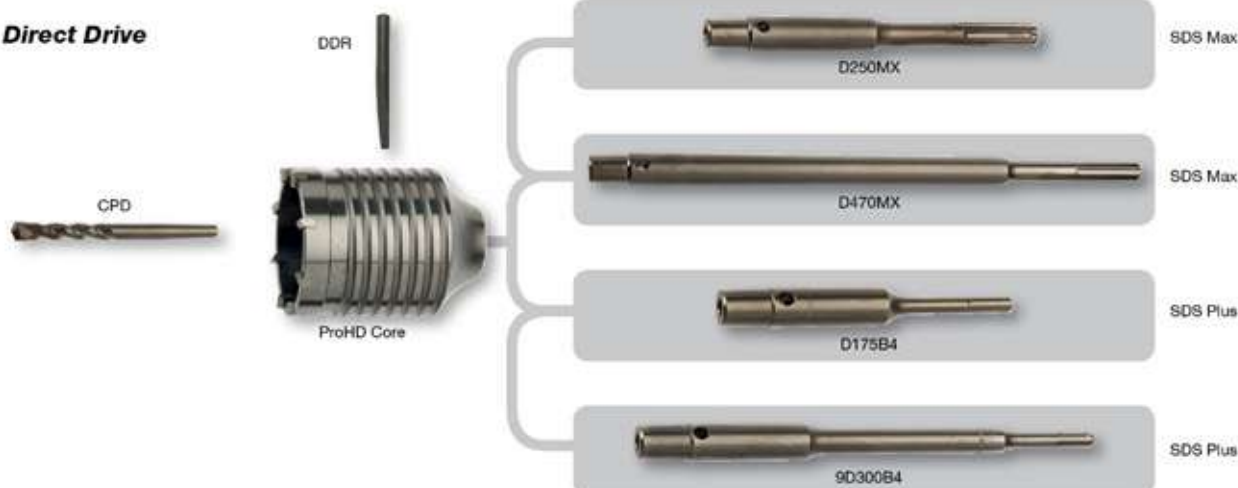

ProHD - Professional Heavy Duty Core Drill Accessories

Description	Shank Type	Thread Type	Length mm	Part Number	
Core Adaptors					
100mm Heavy Duty K Taper Adaptor	K Taper	K Taper	100	D100KHD	
250mm Heavy Duty K Taper Adaptor	K Taper	K Taper	250	D250KHD	
400mm Heavy Duty K Taper Adaptor	K Taper	K Taper	400	D400KHD	
Direct Drive Shank Adaptors					
250mm SDS Max Adaptor	SDS Max	K Taper	250	D250MX	
470mm SDS Max Adaptor	SDS Max	K Taper	470	D470MX	
175mm SDS Plus Adaptor	SDS Plus	K Taper	175	D175B4	
300mm SDS Plus Adaptor	SDS Plus	K Taper	300	9D300B4	
K Taper Drill Holders					
SDS Plus to K Taper Drill Holder	SDS Plus	K Taper (f)	-	HB4K	
SDS Max to K Taper Drill Holder	SDS Max	K Taper (f)	-	HMXK	
K1 Shank to K Taper Drill Holder	21mm a/f hexagon	K Taper (f)	-	HK1K	
Extension Rods					
250mm K Taper Extension Rod - ProHD (For Core sizes 35mm and above)	K Taper	K Taper	250	E250K	
400mm K Taper Extension Rod - ProHD (For Core sizes 35mm and above)	K Taper	K Taper	400	E400K	
Miscellaneous					
Extractor Drift	-	-	-	DDR	
11.0 x 130mm A-Taper Pilot Drill	A Taper	n/a	130mm	CPD	
SDS Max to SDS Plus Quick Fit Adaptor	SDS Max	SDS Plus	-	QFMX	



When used with the relevant adaptor



When used with the relevant adaptor



Coring can be carried out in 'rotary and impact' mode or 'rotary only' mode



Various Direct Drive machines (when used with relevant drill holder and 'K' Taper Adaptor) – please see part number table

Have you tried?

High Speed Masonry Cores



On lighter masonry materials such as block and brick work, the HSM core drills are ideal
See page 43

Perfect for.....
A rapid action core drill ideally matched to SDS Plus Machines



- A Unique Pilot System**
 Unique Armeg original design ball-locking & pilot drill system eliminates the need for awkward grub screws, meaning pilots and arbor can be interchanged quickly for greater convenience
- B Precision Machined Arbor Flats**
 Precision machined arbor flats allow users to easily use grips or a spanner to lock on to the arbor for easy separation of core assembly
- C Tommy Bar Hole**
 Machined Tommy Bar hole allows users to locate a Tommy Bar for hassle free disconnection of arbor and core drills
- D Extremely Thin Wall**
 Manufactured with only a 2.5mm ultra thin wall, there is dramatically reduced drag when drilling meaning the HSM's drill with extreme speed
- E Ultra Hard Tungsten Carbide Tips**
 Ultra hard tungsten carbide tips provide increased wear resistance allowing users to operate the core on 'hammer action' for rapid drilling speeds

DID YOU KNOW? The HSM range was originally produced in response to greater use of lighter masonry building materials where Professional Heavy Duty Cores can be overly powerful. Their popularity rocketed when SDS Plus hammer drills became industry standard

High Speed Masonry Cores can be used in:

- Heavy duty concrete
- General concrete
- Hard bricks
- Soft bricks
- Lightweight blocks
- Natural stone
- Constructional granite
- Limestone



DID YOU KNOW?
 The HSM is an original design and is
 **MADE IN SHEFFIELD**

High Speed Masonry Cores are ideal when working on:

- Waste pipes
- Water feed pipes
- Cable entry / exit
- Flue passage
- Extractor fans
- Exhausts
- Dust extractor ducting

TECH TIP!
 When cleanliness of breakout is critical, turn off hammer action and use 'rotary only' mode for the last part of the drilling process

HSM - High Speed Masonry Core Drills

Diameter Size mm	Overall Length mm	Working Length mm	Part Number
25	85	60	CL25S
30	85	60	CL30S
40	85	60	CL40S
45	85	60	CL45S
50	85	60	CL50S
66	85	60	CL66S
80	85	60	CL80S



HSM - High Speed Masonry Core Drill Accessories

Description	Shank Type	Thread Type	Working Length mm	Part Number
7mm HSM Pilot Drill	Ball retention groove	-	100	CLPDS
200mm HSM Tommy Bar	n/a	-	200	CLTB
100mm SDS Plus Arbor HSM Cores	SDS Plus	M16 x 2.0	100	DL100B4S
300mm SDS Plus Arbor HSM Cores	SDS Plus	M16 x 2.0	300	DL300B4S
100mm Hex Arbor HSM Cores	10mm Hexagon	M16 x 2.0	100	DL100X13S
300mm Hex Arbor HSM Cores	10mm Hexagon	M16 x 2.0	300	DL300X13S

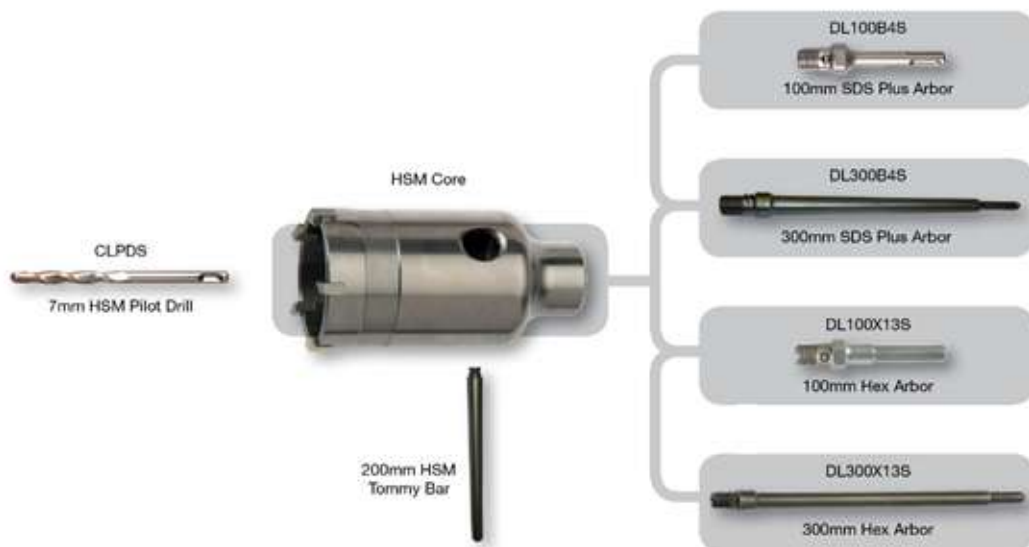
Recommended speed for these cores is largely governed by the power tool itself. This is because they are designed to be used in power tools where in the majority of cases there is no facility to regulate the speed (SDS Plus, SDS Max machines etc.).

If used in a machine where speed regulation is possible, a general recommendation is the larger diameter of the core drill being used, the slower the speed.



When used with the relevant adaptor



M16 x 2.0



Coring can be carried out in 'rotary and impact' mode or 'rotary only' mode

Have you tried?

Dry Diamond Core Drills?



For non-stop deep core drilling in lighter masonry materials such as soft brick & lightweight block.

See page 35



Page
47

SDS Max Points & Chisels

A broad range of chiselling essentials for use with SDS Max machines



Page
49

SDS Plus Channelling & Scutch Comb Chisels

Smarter chiselling designs that solve specific trade jobs with SDS Plus design shanks



Page
51

SDS Plus Points & Chisels

A range of chiselling essentials and job specific chisels, purpose made for SDS Plus machines



Page
53

Diamond Wall Chasing Blades

Perfect for producing rapid tracks in the hardest of Masonary Materials



Material	SDS Max Brick Removing Chisels	SDS Max Points & Chisels	SDS Plus Channelling Chisels	Carbide Tipped Raking Chisels	Scutch Comb Chisels
Heavy Duty Concrete	■	●	■	●	●
General Concrete	■	●	■	●	●
Hard Bricks	■	●	■	●	●
Soft Bricks	■	●	●	●	●
Lightweight Blocks	■	●	●	●	●
Natural Stone	■	●	●	●	●
Constructional Granite	■	●	■	●	●
Limestone	■	●	■	●	●
Mortar	●	●	■	●	●

Material	SDS Plus Points & Chisels	SDS Plus Brick Removing Chisels	SDS Plus Mortar Rake Chisels	Wall Chasing Diamond Blade
Heavy Duty Concrete	●	■	■	●
General Concrete	●	■	■	●
Hard Bricks	●	■	■	●
Soft Bricks	●	■	■	●
Lightweight Blocks	●	■	■	●
Natural Stone	●	■	■	●
Constructional Granite	●	■	■	●
Limestone	●	■	■	●
Mortar	●	●	●	●

Product selector...

Simply choose the material you are working with and use our rating guide to choose which is the best tool for you.

Armeg's Chiselling range centres around a great collection of established points & chisels combined with a whole series of application specific designs which are real problem solvers. Available in both SDS Max and SDS Plus shank designs, the chisel range offers both versatility and technical solutions.

- Very suitable
- Suitable
- Suitable but better alternative
- Not suitable

Perfect for.....

A broad range of chiselling essentials for when the heavy duty impact of SDS Max machines is required

Brick Removal Chisels



Tungsten Carbide Tipped Blade - G280MXBC



Un-Tipped Blade - G280MXBC30/3

Ideal for:

Hammering out the mortar around individual bricks or blocks to allow brick removal for applications such as installing brick lights, air bricks, replacing damaged brickwork, cavity access etc. Available in a carbide tipped version for longer life and durability

Use in:

Mortar

General Purpose Chisels



G360MXC / G500MXC



G80MXSC / G50MXSC

Ideal for:

General Purpose Chisels with varying lengths and blade widths. Typical applications are light demolition work, breakthrough work, chiselling, plaster and render removal, block splitting etc

Use in:

Heavy duty concrete, general concrete, hard bricks, soft bricks, lightweight blocks, natural stone, constructional granite, limestone, mortar

Pointed Chisels



G360MXP

G500MXP

Ideal for:

Our Pointed Chisels are available in two different lengths and are perfect for breaking out the cores of material left in place after core drilling

Use in:

Heavy duty concrete, general concrete, hard bricks, soft bricks, lightweight blocks, natural stone, constructional granite, limestone, mortar

DID YOU KNOW?

Precisely forged & machined chisel heads ensure SDS Max Points & Chisels are securely held for maximum chiselling action

TECH TIP!

SDS Max shanks should be greased prior to and during use. This reduces heat build-up which reduces wear on the chisel and the machine

SDS Max Points & Chisels

Description	Blade Width mm	Overall Length mm	Working Length mm	Part Number	
Brick Removing Chisel - Carbide Tipped <small>Contains 2 carbide teeth</small>	4.5	280	-	G280MXBC	
Brick Removing Chisel - Un-tipped	3	280	-	G280MXBC30/3	
360mm Chisel	25	360	-	G360MXC	
360mm Point	-	360	-	G360MXP	
500mm Chisel	25	500	-	G500MXC	
500mm Point	-	500	-	G500MXP	
50mm Wide Chisel	50	400	-	G50MXSC	
80mm Wide Chisel	80	300	-	G80MXSC	

Prior to using chisels, please ensure your machine has the 'chisel only' function as they are designed to be used on this function only.



**Perfect for.....
Smarter chiselling designs to solve
specific trade jobs**

Channelling Chisels



Ideal for:
An innovative range of channelling chisels which feature precision ground cutting edges combined with cranked shafts to rapidly produce channels for conduit installations

Typical applications include:
30mm - electrical conduit or pipe work
55mm - double conduit runs or when using capping
20mm extended - running cables behind skirting boards or ceiling coving

Use in:
Medium density block work, soft bricks, lightweight blocks, natural stone

Carbide Tipped Raking Chisels



Ideal for:
Working in the toughest masonry and concrete. The solid tungsten carbide strip insert provides the ultimate performance in material removal

Use in:
Heavy duty concrete, general concrete, hard bricks, soft bricks, lightweight block, natural stone, constructional granite, limestone, mortar

Scutch Comb Chisel



Ideal for:
Scutch Comb Holders for general masonry tasks e.g. masonry dressing, levelling uneven masonry surfaces, forming channels, back box holes etc

Use in:
General concrete, soft bricks, lightweight blocks, mortar, limestone, constructional granite, natural stone, hard bricks, heavy duty concrete

DID YOU KNOW?

Our SDS Plus Channelling & Scutch Comb Chisels are precision manufactured with quality forgings to provide durable steel with proven performance standards

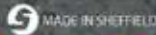

TECH TIP!

Channelling Chisels can be sharpened when the cutting edges become blunt, ideally using a grinder or good quality file and replicating the original profile as much as possible

TECH TIP!

It is necessary to try and keep all Scutch Comb teeth in contact with the material being chiselled to avoid the comb being levered out of the holder

Scan me for demo video of Channelling Chisels



SDS Plus Channelling & Scutch Comb Chisels

Description	Diameter Size mm	Overall Length mm	Working Length mm	Part Number	
30mm Channelling Chisel	30	225	-	G225B4CC30	
55mm Channelling Chisel	55	225	-	G225B4CC50	
20mm Extended Channelling Chisel	20	310	-	G310B4CCSB	
30mm Wide Raking Chisel - Carbide Tipped Solid-section carbide tip	30	150	-	G30B4CCCT	
55mm Wide Raking Chisel - Carbide Tipped Solid-section carbide tip	55	150	-	G55B4CCCT	
Scutch Comb Chisel - for 40mm Combs Uses SCCO combs	-	200	-	G150B4SCH	
40mm Scutch Comb Fits directly into G150B4SCH	-	n/a	-	SCCO	
40mm Scutch Comb - pack of 5	-	-	-	SCCOX5	
Scutch Comb Chisel - for 25mm Combs Uses SCCO1 combs	n/a	200	n/a	G150B4SCH1	
25mm Scutch Comb Fits directly into G150B4SCH1	n/a	n/a	n/a	SCCO1	
25mm Scutch Comb - Pack of 5	n/a	n/a	n/a	SCCO1X5	

TECH TIP!

SDS Plus shanks should be greased prior to and during use. This reduces heat build-up which reduces wear on the chisel and on the machine



DID YOU KNOW?

Each TC raking chisel is as short as possible for added power transmission to improve chiselling performance

Prior to using chisels, please ensure your machine has the 'chisel only' function as they are designed to be used on this function only



Have you tried?
SDS Max Points & Chisels



Designed for use in SDS Max machines when working in the toughest masonry and concrete See page 47

Perfect for.....
A range of chiselling essentials and job specific chisels, purpose made for SDS Plus machines

Mortar Raking Chisel
Carbide Tipped

G175B4MRC6



Ideal for:

A cranked shaft chisel which is purpose designed to not "dive-in" to mortar lines, but effectively chisel away stubborn mortar. The cranked shaft allows for access behind down-pipes and close up to door and window frames for a neat finish without damage

Use in:

Mortar

Brick Removing Chisel
Carbide Tipped

G230B4BC



Ideal for:

Cavity inspection work when brick removal is the only option. The carbide tips provide efficient mortar removal and wear resistance

Use in:

Mortar

Tile Removing Chisel

G80SDSTR



Ideal for:

The cranked shaft chisel is purpose designed to allow a rapid tile lifting action without 'dragging' the machine along the floor. User comfort is enhanced and avoids hours of labour intensive manual chiselling to remove tiles and plaster

Use in:

Tile, plaster, render removal applications

DID YOU KNOW?

Armeg's application specific designs are

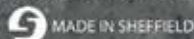

with some featuring Tungsten Carbide Inserts for added durability

Scan me for demo video



TECH TIP!

SDS Plus shanks should be greased prior to and during use. This reduces heat build-up which reduces wear on the chisel and on the machine



80mm Wide EBS Hard Material Chisel

EBS.BSC.HM



Ideal for:

Producing repeated numbers of electrical back box holes in tough masonry. User convenience is assured by avoiding hours of labour intensive manual chiselling to knock out holes for electrical back boxes

Use in:

Heavy duty concrete, general concrete, hard bricks, soft bricks, lightweight blocks, natural stone, constructional granite, limestone, mortar

General Purpose Chisels

G250B4P



G250B4C



G250B4SC









Ideal for:

Everyday essential chisels, perfect for transmitting the hammer blow of SDS Plus machines for general masonry removal jobs. SDS Plus Points are great for breaking out the core of material still in contact with the drilled substrate after core drilling

Use in:

Heavy duty concrete, general concrete, hard bricks, soft bricks, lightweight blocks, natural stone, constructional granite, limestone, mortar

SDS Plus Points & Chisels

Description	Blade Width mm	Overall Length mm	Working Length mm	Part Number	
Mortar Raking Chisel - Carbide Tipped	6	185	-	G175B4MRC6	
Brick Removing Chisel - Carbide Tipped	4.5	220	-	G230B4BC	
Tile Removing Chisel	80	180	-	G80SDSTR	
80mm Wide EBS Hard Material Chisel	80	150	-	EBS.BSC.HM	
250mm Chisel	20	250	-	G250B4C	
250mm Point	-	250	-	G250B4P	
40mm Wide Scaling Chisel	40	250	-	G250B4SC	

Prior to using chisels, please ensure your machine has the 'chisel only' function as they are designed to be used on this function only



Have you tried?
SDS Max Points & Chisels



Designed for use in SDS Max machines when working in the toughest masonry and concrete See page 47

Perfect for.....
fast tracks that go the distance



- A 13mm Diamond Segments**
Provide increased abrasive resistance for extended tool life
- B Turbo Segment Design**
Dramatically reduces blade drag for extreme cutting speed
- C Cooling Slots**
In the turbo segments clear waste for prolonged life and durability
- D Optimum Diamond Concentration**
In blade segments allows the production of rapid tracks in the hardest materials

Diamond Blades can be used in:

- General Concrete
- Hard Bricks
- Soft Bricks
- Lightweight Blocks
- Natural Stone
- Constructional Granite
- Limestone
- Mortar

DID YOU KNOW?

Armeg Wall Chasing Diamond Blades have special slots in them which aid cooling and reduce the chances of the blade overheating whilst it is cutting

Ideal for:

- Producing rapid tracks in the hardest of masonry materials for conduit and sheath installation.



TECH TIP!

Pay close attention to the direction arrows on the blade when mounting on machine. The direction arrow on the blade should correspond with the one on the machine

Diamond Blades

Description	Segment H x W mm	Blade Diameter mm	Bore Diameter mm	Part Number	
125mm Wall Chasing Diamond Blade (Twin Pack - contains 2 blades)	13 x 2.2	125	22.2	DWCB125TP	

Operation Speed Chart

Product	Recommended
Diamond Wall Chasing Blade	80m/s 12220rpm



Wall Chasing
Diamond Blades



Wall Chasing
Diamond Blades

Have you tried?

SDS Plus Channelling Chisels



*An innovative range
of channelling chisels
ideal for conduit installation
in softer materials.*

See page 50



Page
57



Nail-Proof WoodBeaver

The solution to drilling in nail embedded wood

Page
59



WoodBeaver

The smoothest & fastest wood drill bits available

Page
61



Wood Auger Drill Bits - Hexagon & SDS Plus Shank

Ideal for deep hole drilling

Page
63



Flat Wood Drill Bits

The convenient, value option for fast & economical holes

Page
65



Brad Point Wood Drill Bits

A superb option for drilling small diameter holes from 3 – 10mm

Material	Nail-Proof WoodBeaver	WoodBeaver	Wood Auger Drill Bits	Flat Wood Drill Bits	Brad Point Drill Bits
Hard Wood	●	●	●	●	●
Soft Wood	●	●	●	●	●
Nail Embedded Wood	●	●	●	■	■
Veneered Chipboard	●	●	●	●	●
Plywood	●	●	●	●	●
Chipboard	●	●	●	●	●

Product selector...

Simply choose the material you need to drill and use our rating guide to choose which is the best tool for you.

Our extensive range of Wood Drill Bits provides a great choice of options for all wood drilling applications. From the value and convenience of flat wood drill bits, up to the premium performance of Nail-Proof Wood Beaver drill bits, there is a drill bit designed for every application.

- Very suitable
- Suitable
- Suitable but better alternative
- Not suitable



Perfect for.....
The solution to drilling in nail embedded Wood



- A** ¼" quick-change shank* for added convenience and rapid diameter tool change. Impact rated for impact drivers.
- B** Four deep auger style flutes for rapid chip evacuation and faster drilling speeds
- C** Four precision ground cutting teeth for extreme drilling comfort and balance
- D** Robust cutting tooth profile provides **extreme resistance to hard objects such as nails**
- E** High Speed Steel cutting head increases **durability in tough materials for longer life**

*Apart from 32mm which has a 7/16" shank & can't be used in impact drivers



The 120mm Stubby Is Ideal for:

- Inter-joist drilling
- Working in tight spaces
- Users with larger drilling machines

The Nail-Proof WoodBeaver is ideal for:

- Drilling nail embedded Wood
- Inter-joist drilling
- Producing cable / pipe passages through timber etc



The Nail-Proof WoodBeaver can be used in:

- Nail embedded Wood
- Softwoods
- Hardwoods
- Veneered chipboard
- Plywood
- Chipboard

Scan me for demo video



TECH TIP!

Up to 25mm diameter can be used within an impact driver. This gives the advantages of one-handed operation and improved access in tight spaces

Nail-Proof WoodBeaver

Diameter Size mm	Overall Length mm	Working Length mm	Part Number
16	165	125	WWBNP16
20	165	125	WWBNP20
22	165	125	WWBNP22
25	165	125	WWBNP25
32	165	125	WWBNP32

Nail-Proof Stubby WoodBeaver

Diameter Size mm	Overall Length mm	Working Length mm	Part Number
16	120	80	WWBNPST16
20	120	80	WWBNPST20
22	120	80	WWBNPST22
25	120	80	WWBNPST25
32	120	80	WWBNPST32

4 Piece Nail-Proof Stubby Set

Description	Set Contents	Part Number
4 Piece Nail-Proof Stubby Set	1 X 16 / 20 / 25mm 1 X Quick-Change SDS Plus to 1/4" Adaptor	WWBNP4PCSET

WoodBeaver Accessories

	Drive Type	Length mm	Internal mm	Technical Product Detail	Part Number
Quick-Change SDS Plus to 1/4" Adaptor *Twister Impact rated for impact drivers	SDS Plus	60	1/4"	For Sizes 10 - 25mm	SDS1/4WB055
7/16" SDS Plus drive adaptor	SDS Plus	90	7/16"	For Sizes 32mm only	SDS7/16WB090
Quick-Change 1/4" Extension Rod *Twister Impact rated for impact drivers	1/4" Hexagon	230	1/4"	For Sizes 10 - 25mm	WWB1/4HEX250





32mm WoodBeavers have min. chuck requirement of 13mm



1/4" shank (except 32mm WoodBeavers)
7/16" shank (32mm WoodBeaver only)



When used with relevant adaptor



M6x6 (7/16" adaptor grubscrews)



7/16" adaptor grubscrews



Up to 25mm only



Perfect for.....
The smoothest and fastest wood drill bits available



- A** 1/4" Quick-Change shank* for added convenience and rapid diameter tool change. Impact rated for impact drivers.
- B** Short lightweight body construction for maximum holes per charge in cordless machines
- C** Four deep auger style flutes for rapid chip evacuation and faster drilling speeds
- D** Four precision ground cutting teeth for extreme drilling comfort and balance
- E** Purpose designed head geometry for ultra clean breakthrough

*Apart from 32mm which has a 7/16" shank & can't be used in impact drivers.

STUBBY LENGTH
Ideal for Joists

The 120mm Stubby WoodBeaver is Ideal for:

- Inter-joint drilling
- Working in tight spaces
- Users with larger drilling machines

DID YOU KNOW?

All WoodBeaver designs are precisely back-tapered along the length of the flute. The design is invisible to the naked eye, but creates a jam-free, smooth action when removing drill bits from holes drilled in wood



WoodBeaver can be used in:

- Hardwoods
- Softwoods
- Veneered chipboard
- Plywood
- Chipboard

WoodBeaver is ideal for:

- Producing cable / pipe passages through timber etc

TECH TIP!

When being used in a cordless drill, the larger WoodBeavers should be used on the slowest speed. The slowest speed gives the higher torque required. Using on higher speeds only provides a low torque which could stall the machine out

Scan me for demo video



WoodBeaver

Diameter Size mm	Overall Length mm	Working Length mm	Part Number
10	165	125	WWB10.0T
12	165	125	WWB12.0T
13	165	125	WWB13.0T
16	165	125	WWB16.0T
18	165	125	WWB18.0T
19	165	125	WWB19.0T
20	165	125	WWB20.0T
22	165	125	WWB22.0T
25	165	125	WWB25.0T
32	165	125	WWB32.0T
4 Piece WoodBeaver Set	1 X 16 / 20 / 25 / 32mm		WWB4PCSET



Stubby WoodBeaver

Diameter Size mm	Overall Length mm	Working Length mm	Part Number
16	120	80	WWBST16
20	120	80	WWBST20
22	120	80	WWBST22
25	120	80	WWBST25
32	120	80	WWBST32
3 Piece Stubby WoodBeaver Set	1 X 16 / 20 / 25mm 1 X Quick-Change SDS Plus to 1/4" Adaptor		WWB3PCSET120



WoodBeaver Accessories

	Drive Type	Length mm	Internal mm	Technical Product Detail	Part Number
Quick-Change SDS Plus to 1/4" Adaptor <small>*Twister Impact rated for impact drivers</small>	SDS Plus	60	1/4"	For Sizes 10 - 25mm	SDS1/4WB055
7/16" SDS Plus drive adaptor	SDS Plus	90	7/16"	For Sizes 32mm only	SDS7/16WB090
Quick-Change 1/4" Extension Rod <small>*Twister Impact rated for impact drivers</small>	1/4" Hexagon	230	1/4"	For Sizes 10 - 25mm	WWB1/4HEX250



32mm Wood Beavers have min. chuck requirement of 13mm



1/4" shank (except 32mm WoodBeavers)

7/16" shank (32mm WoodBeaver only)

When used with relevant adaptor

M6x6 (7/16" adaptor grub screws)

3mm (7/16" adaptor grub screws)

Up to 25mm only



Perfect for.....
Deep hole drilling in a wide range of diameters

- A Back Tapered Flute**
 Precision ground back tapered flute prevents drill from jamming in holes and provides easy tool removal
- B Thin Core**
 Thin body core with deep flutes allows greater removal of wood chips
- C 'In Flute' Steam Tempering**
 The 'In Flute' is steam tempered to provide a smooth finish which allows rapid removal of wood chips and faster drilling
- D Precision Machined 'Spur'**
 Precision machined 'spur' scores the outline of the hole into the wood, helping the bit to stay true and produce clean holes with minimal break through
- E Screw Tip**
 Screw tip pulls the auger through the wood for added ease of use and minimal user effort

Wood Augers can be used in:

- Hardwoods
- Softwoods
- Veneered chipboard
- Plywood
- Chipboard

Wood Augers are ideal when:

- Producing holes in timber from 6-32mm
- Cable or pipe passage through joists

Our wood augers are available on either a Hex or SDS Plus shank to fit your machine requirements



DID YOU KNOW?

Wood Augers are one of the oldest drill bit designs still in manufacture today and were originally produced with shank designs to fit into manually operated drilling braces

TECH TIP!

Our Wood Augers are available in a variety of lengths ranging from 100mm to 450mm

Wood Auger Drill Bits - SDS Plus shank

Diameter Size mm	Overall Length mm	Working Length mm	Part Number
8	205	125	WS08.0X205
10	205	125	WS10.0X205
12	205	125	WS12.0X205
12	400	360	WS12.0X400
16	205	125	WS16.0X205
16	400	360	WS16.0X400
20	205	125	WS20.0X205
22	205	125	WS22.0X205
22	400	360	WS22.0X400
25	205	125	WS25.0X205



Wood Auger Drill Bits - Hexagon Shank

Diameter Size mm	Overall Length mm	Working Length mm	Part Number
6	235	160	WH06.0X235
8	235	160	WH08.0X235
10	235	160	WH10.0X235
10	450	380	WH10.0X450
12	235	160	WH12.0X235
12	450	380	WH12.0X450
13	235	160	WH13.0X235
16	235	160	WH16.0X235
16	450	380	WH16.0X450
18	235	160	WH18.0X235
20	100	65	WH20.0X100
20	235	160	WH20.0X235
20	450	380	WH20.0X450
22	235	160	WH22.0X235
22	450	380	WH22.0X450
25	155	110	WH25.0X155
25	235	160	WH25.0X235
25	450	380	WH25.0X450
32	155	110	WH32.0X155
32	235	160	WH32.0X235



Operation Speed Chart

Diameter Size mm	Softwood RPM	Hardwood RPM
6 - 10	2000	1500
11 - 15	1500	1250
16 - 20	1250	1000
21 - 25	1000	750
26 - 32	750	50

*Please visit www.armeg.co.uk for full operation speed chart



Perfect for.....

The convenient, value option for fast & economical holes



- A** Ground centre-point centres the drill bit for a secure non-slip start
- B** Precision ground, transverse cutting edges rapidly cut whilst simultaneously lifting debris from the cutting edge for rapid drilling and longer life
- C** Raised spurs score the wood in advance of the cutting edge allowing it to cut more easily and effectively which gives users a faster, more comfortable drilling experience
- D** Back tapered drilling head avoids jamming in holes for smooth and hassle free drilling
- E** 1/4" Quick-Change shank is manufactured to ISO 1173-2001 for hassle free bit changes

Flat Wood Bits can be used in:

- Veneered chipboard
- Plywood
- Chipboard
- Hardwoods
- Softwoods

Flat Wood Bits are ideal when:

- An economical way of producing holes from 10 – 38mm diameter is required
- Controllable or fixed depth of cut is preferred
- Fitting door locks

DID YOU KNOW?

The small hole in the flat part of the drill was originally designed to help users thread wires by allowing them to attach the wire to the drill bit and pull it through the drilled hole

TECH TIP!

Withdrawing frequently during the drilling process can speed up the drilling rates by helping to clear the spoil from the hole



Flat Wood Drill Bits

Diameter Size mm	Overall Length mm	Working Length mm	Part Number
10	152	112	WF10.0X160
12	152	112	WF12.0X160
13	152	112	WF13.0X160
16	152	112	WF16.0X160
18	152	112	WF18.0X160
19	152	112	WF19.0X160
20	152	112	WF20.0X160
22	152	112	WF22.0X160
25	152	112	WF25.0X160
26	152	112	WF26.0X160
28	152	112	WF28.0X160
30	152	112	WF30.0X160
32	152	112	WF32.0X160
38	152	112	WF38.0X160



Description	Set Contents	Part Number
6 Piece Flat Wood Drill Bit Set	13 / 16 / 20 / 22 / 25 / 32 mm	WF6SET



**Need extra reach?
Want to use an SDS machine?**

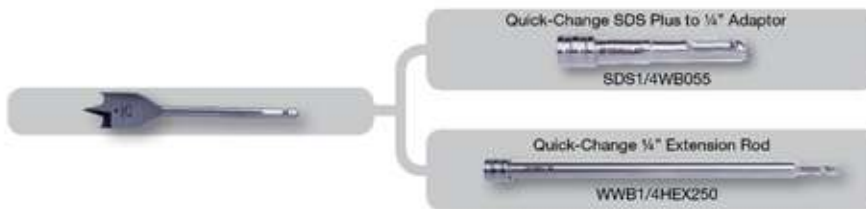

See page 58 for further information on the adaptors

This product is not impact rated and we do not advise using in impact drivers. The quick-change extension and SDS Plus adaptor we recommend to be used with this product are themselves impact rated and can be used with any of our Twister impact rated products in an impact driver. However, if using with Flat Wood Bits we advise against using in an impact driver and instead use in an alternative 3 jaw chuck machine on rotary only.

Operation Speed Chart

Diameter Size mm	Softwood	Hardwood
6 - 13	2000	1500
14 - 25	1750	1500
26 - 38	1500	1000

*Please visit www.armeg.co.uk for full operation speed chart



If used with the relevant adaptor and 3 Jaw Chuck. Do not use on impact

1/4" shank
This product is not impact rated

Have you tried?
WoodBeaver



Trade up to the WoodBeaver for the ultimate performance in speed and smoothness of cut See page 59

Perfect for.....
A superb option for drilling small diameter holes from 3 - 10mm



- A** Manufactured with HSS chrome vanadium steel for durability and the ideal amount of drill flexibility
- B** Fully fluted drill body results in effective chip removal, even in deeper holes, for smooth and progressive drilling
- C** Twin raised side cutting spurs lead the cutting by first scoring the periphery of the hole to maximise the chances of cleanly cut wood fibres for a neater finish
- D** Precision machined centre point gives pin point hole location and rapid start-up, meaning holes are produced exactly where required for precise and accurate drilling

Brad Points can be used in:

- Hardwood
- Plywood
- Chipboard
- Natural hard and soft woods

Brad Points are ideal when working on:

- Applications where accurate small diameter holes are required in wood
- Dowelling



DID YOU KNOW?

Brad points remain the only purpose designed small diameter drill bit for drilling wood

TECH TIP!

Withdrawing frequently during the drilling process can speed up the drilling rates by helping to clear spoil from the hole

Brad Point Wood Drill Bits

Diameter Size mm	Overall Length mm	Working Length mm	Part Number
3	65	40	WBP0300
4	75	45	WBP0400
5	85	60	WBP0500
6	90	60	WBP0600
7	100	60	WBP0700
8	105	65	WBP0800
10	115	85	WBP1000



Operation Speed Chart

Diameter Size mm	Softwood	Hardwood
3	1800	1200
4	1800	1200
5	1800	1000
6	1800	1000
7	1800	1000
8	1800	1000
10	1800	750

*Please visit www.armeg.co.uk for full operation speed chart



If used with the relevant adaptor and 3 Jaw Chuck. Do not use on impact

Have you tried?
HSS Drill Bits



Only HSS Bits, principally designed for drilling steel provide an alternative to drilling small diameter holes in wood
See page 85



Page **69** **LDX Metal - Carbide Tipped Holesaws**
 The ultimate for extreme tool life in thick and thin stainless steel



Page **71** **CIR Range - Pro-Step Drills**
 Up to 13 drill diameter steps on one tool for multiple hole diameter options



Page **71** **CIR Range - Quick-Cone Drills**
 The most versatile tool for sheet steel and perfect for enlarging existing holes



Page **73** **Acceler8% - Sheet Steel Holesaws & Accessories**
 The fastest way to drill sheet steel



Page **75** **CVP - Cobalt Vari-Pitch Holesaws**
 The ultimate multi purpose holesaw with .8% cobalt for longer life



Page **77** **Bi-Metallic HSS Holesaws**
 A great value holesaw for drilling multiple materials



Page **79** **Holesaw Accessories**
 Adaptors & Accessories for your holesaw



Page **81** **16 Piece Twister Drilling Set**
 Features Armeg's premium quality drill bits all impact rated for impact drivers



Material	LDX	Pro-Step	Quick-Cone	Acceler8%	CVP	Bi-Metallic Holesaws
Mild Steel	●	●	●	●	●	●
Stainless Steel	●	●	●	●	●	●
Cast Iron	●	●	●	●	●	●
Aluminium	●	●	●	●	●	●
Brass	●	●	●	●	●	●
Wood	■	●	●	●	●	●
Plastic	●	●	●	●	●	●

- Very suitable
- Suitable
- Suitable but better alternative
- Not suitable

Product selector...

From the table above simply choose the material you need to drill and use our rating guide to choose which is the best tool for you.

Covering all materials and all thicknesses, we offer solutions for large diameter metal drilling based around your specific job requirements. Whether it's versatility to drill different materials or a high performance option to drill stainless steel, we offer a solution. The latest product to complete the range is the Acceler8% range of sheet steel holesaws which are the fastest way to drill sheet steel.

**LDX
METAL**

Perfect for.....
Extreme tool life when drilling repeat holes in thick and thin stainless steel



Long Series
 Drills steel up to 25mm thick



Short Series
 Drills steel up to 4.75mm thick

- A One Piece Construction**
 No assembly required
 Enables accurate drilling
- B Safety Collar Stop**
 Prevents over penetration for safer, faster operation
- C Special Tungsten Carbide Teeth**
 Excellent wear and heat resistance
 Cuts stainless steel and tough alloys
- D Ejector Spring**
 Ejects the slug for time saving convenience

It can be used in:

- Steel
- Stainless steel
- Cast iron
- Aluminium
- Copper

TECH TIP!

Using cutting oil will extend product life and is imperative in stainless steel
 Try our Cutting Compound (ECC002) see page 128

DID YOU KNOW?

Our life testing has shown that up to 350 holes can be drilled in stainless steel compared to just 10 holes with some standard holesaws

LDX is ideal when working on:

- Metal enclosures, trunking, cabinets, cladding, switchgear (especially stainless steel)
- Structural steelwork (I-beams, hollow structural section, angles, channels, tees, rail profile, open web steel joists, bar, rod, plate etc)
- Pipework



Scan me for demo video



Diameter Size mm	Overall Length mm	Working Length mm	Part Number
Short Series			
14	65	4.75	LDXM014SS
16	65	4.75	LDXM016SS
20	65	4.75	LDXM020SS
22	65	4.75	LDXM022SS
25	65	4.75	LDXM025SS
32	65	4.75	LDXM032SS



Long Series			
14	80	25	LDXM014LS
16	80	25	LDXM016LS
18	80	25	LDXM018LS
19	80	25	LDXM019LS
20	80	25	LDXM020LS
22	80	25	LDXM022LS
25	80	25	LDXM025LS
28	80	25	LDXM028LS
30	80	25	LDXM030LS
32	80	25	LDXM032LS
35	80	25	LDXM035LS
38	80	25	LDXM038LS
40	80	25	LDXM040LS
41	80	25	LDXM041LS
45	80	25	LDXM045LS
50	80	25	LDXM050LS
51	80	25	LDXM051LS
55	80	25	LDXM055LS
60	80	25	LDXM060LS
65	80	25	LDXM065LS
75	80	25	LDXM075LS



All LDX Cutters are supplied with pilot drills, ejector springs & an allen key

Accessories

Description	Diameter mm	Overall Length mm	Working Length mm	Part Number
Pilot drill - Short Series	6.5	52	16	LDXMPILSS
Pilot drill - Long Series	6.5	77	26	LDXMPILLS
Spring - Short Series	n/a	n/a	n/a	LDXMSPRSS
Spring - Long Series	n/a	n/a	n/a	LDXMSPRLS



Operation Speed Chart - Short Series LDX

Diameter Size mm	Stainless Steel & Alloy Steel RPM	Mild Steel RPM
14 - 21	300 - 700	700 - 1000
22 - 30	200 - 450	500 - 800
31 - 40	175 - 315	300 - 600
41 - 50	120 - 225	200 - 500

Operation Speed Chart - Long Series LDX

Diameter Size mm	Stainless Steel & Alloy Steel RPM	Mild Steel RPM
14 - 20	310 - 470	470 - 630
21 - 25	250 - 380	380 - 510
26 - 30	210 - 310	310 - 420
31 - 35	180 - 270	270 - 360



10 & 13mm



LDX
up to 50mm



LDX
14-75mm



M6x6



3mm

Designed with a precision manufacturing process, the drills produce rapid, clean and professional holes for quality conduit installation

PRO-STEP

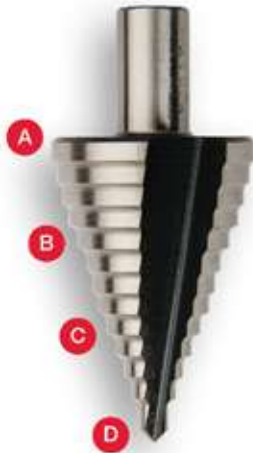

Perfect for...
Consistently accurate holes in trunking and sheet steel

- A** Up to 13 drill diameter steps for convenience and multiple hole diameter options
- B** Laser etched diameter markings allow repeat production of error free, reliably accurate holes
- C** Fully ground body profile for perfectly round burr free holes
- D** Precision ground, tapered cutting edges allow material up to 6mm to be drilled

QUICK-CONE™



Perfect for...
Producing an infinite range of hole diameters for versatility in trunking and sheet steel

- A** Uninterrupted, ground cutting edges rapidly produce an infinite range of hole diameters for ultimate versatility
- B** Tapered cone design for easily enlarging holes, perfect for problem solving and awkward jobs
- C** Self Centring drilling action provides a quick & easy trade solution for metal drilling

TECH TIP!

The shanks on the CIR range are deliberately ground "lobed" (out of round). This prevents them slipping in the power tool chuck. Chucks should be tightened onto the lowest points of the lobed shank

DID YOU KNOW?

Pro-Step and Quick-Cone™ are



The CIR Range is ideal for:

- Holes of up to 35mm in metal enclosures, trunking, cabinets, cladding, switchgear etc
- Easily opening up existing holes
- Jobs which require specific tools with diameters suitable for ISO threads and clearance holes
- Applications where many different diameters are required which are available on one tool



Pro-Step and Quick-Cone can be used in:

- Sheet steel
- Non-ferrous metals
- Plastics
- Formica
- Plywood

Scan me for demo video



Designed with a precision manufacturing process, the drills produce rapid, clean and professional holes for quality conduit installation

PRO-STEP

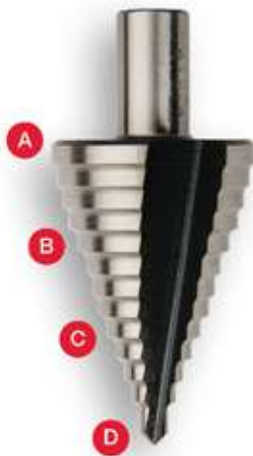

Perfect for...

Consistently accurate holes in trunking and sheet steel

- A** Up to 13 drill diameter steps for convenience and multiple hole diameter options
- B** Laser etched diameter markings allow repeat production of error free, reliably accurate holes
- C** Fully ground body profile for perfectly round burr free holes
- D** Precision ground, tapered cutting edges allow material up to 6mm to be drilled

QUICK-CONE™



Perfect for...

Producing an infinite range of hole diameters for versatility in trunking and sheet steel

- A** Uninterrupted, ground cutting edges rapidly produce an infinite range of hole diameters for ultimate versatility
- B** Tapered cone design for easily enlarging holes, perfect for problem solving and awkward jobs
- C** Self Centring drilling action provides a quick & easy trade solution for metal drilling

TECH TIP!

The shanks on the CIR range are deliberately ground "lobed" (out of round). This prevents them slipping in the power tool chuck. Chucks should be tightened onto the lowest points of the lobed shank

DID YOU KNOW?

Pro-Step and Quick-Cone™ are



The CIR Range is ideal for:

- Holes of up to 35mm in metal enclosures, trunking, cabinets, cladding, switchgear etc
- Easily opening up existing holes
- Jobs which require specific tools with diameters suitable for ISO threads and clearance holes
- Applications where many different diameters are required which are available on one tool

Scan me for demo video



Pro-Step and Quick-Cone can be used in:

- Sheet steel
- Non-ferrous metals
- Plastics
- Formica
- Plywood

Pro-Step - Step Drills

Diameter Size mm	Typical Applications Step Increments (mm)	Start Diameter	Min. Chuck Req.	Max Material Thickness	Recommended RPM			Part Number
					Mild Steel	Stainless	Non-Ferrous	
4 - 22	4, 6, 8, 10, 12, 14, 16, 18, 20, 22	4mm	10mm	5mm	400	150	400-1000	EMWSD04-22
5 - 35	5, 7.5, 10, 13, 16, 19, 21, 23, 26, 29, 31, 33, 35	5mm	13mm	3.5mm	300	100	300-700	EMWSD05-35
16 - 25	16.25, 20.25, 25.25	Approx 6mm	10mm	3.5mm	400	150	400-1000	ESD16-25
16 - 32	16.5, 20.5, 25.5, 32.5	Approx 11mm	13mm	3.5mm	300	130	300 - 800	ESD16-32
12 - 25 ISO	10.5 Core size for M12x1.5 conduit thread (tapping)	6.5mm Approx	10mm	6mm (tapping) 3mm (clearance)	400	150	400-1000	ESDISO12-25
	12.5 Clearance for 12mm conduit							
	14.5 Core size for M16x1.5 conduit thread (tapping)							
	16.5 Clearance for 16mm conduit							
	18.5 Core size for M20x1.5 conduit thread (tapping)							
20.5 Clearance size for 20mm conduit								
23.5 Core size for M25x1.5 conduit thread (tapping)								
25.5 Clearance size for M25 conduit								



Quick-Cone - Cone Drills

Diameter Size mm	Typical Applications	Start Diameter	Min. Chuck Req.	Max Material Thickness	Recommended RPM			Part Number
					Mild Steel	Stainless	Non-Ferrous	
20 & 25	Graduation at 20mm and stop at 25mm to help produce 20 & 25mm conduit entry holes	16mm	10mm	2mm	400	150	400-1000	ECD20-25
6 - 20	General Purpose	6mm	10mm	2mm	600	200	500-1500	ECD06-20
9.5 - 22.5	Finishing size is international standard hole size for push buttons and indicator lights	9.5mm	10mm	2mm	600	200	500-1500	ECD09.5-22.5
16 - 30.5	Finishing size is international standard hole size for push buttons and indicator lights	16mm	10mm	2mm	400	150	400-1000	ECD16-30.5
25 - 40	General Purpose	25mm	10mm	2mm	300	100	300-500	ECD25-40
16 - 25	General Purpose	16mm	10mm	2mm	400	150	400-1000	ECD16-25



Please refer to data chart for chuck requirements

See more **CIR Range**



Re-Threaders & Conduit Threading Set - Page 127



Acceler8% Sheet Steel Holesaw

Diameter Size mm	Overall Length mm	Working Length mm	Part Number
14	65	1.6	SSH014
16	65	1.6	SSH016
18	65	1.6	SSH018
20	65	1.6	SSH020
22	65	1.6	SSH022
25	65	1.6	SSH025
30	65	1.6	SSH030
32	65	1.6	SSH032
35	65	1.6	SSH035
38	65	1.6	SSH038



Accessories

Description	Diameter mm	Overall Length mm	Working Length mm	Part Number
Replacement Spring	n/a	n/a	n/a	SSHSPR
Replacement Drive Adaptor/Pilot Drill	4	65	12	SSHDP
3 Piece Set		1 X 20 / 25 / 32mm 1 x Drive Pilot 1 x Spring 1x 2.5mm Allen Key		SSH3PCSET

Acceler8% comes pre-assembled with drive adaptor and spring ready for instant use

Acceler8% Operation Speed Chart

Dimension Size mm	Mild Steel RMP	Stainless Steel RPM	Aluminium RPM
20	430	210	645
25	350	175	525
32	275	140	410

*Please visit www.armeg.co.uk for full operation speed chart

DID YOU KNOW?

The cheetah is the fastest land animal in the world and can acceler8% from 0-60mph in 3.4 seconds



10 & 13mm



M5x5



2.5mm



1/4" Shank





Perfect for.....
The ultimate multi-purpose holesaw with 8% cobalt for longer life



A Stronger Flex-Free Body Construction
 Stronger Flex-free body construction designed with high alloy content for structural integrity and tool dependability

B M42 Superior Steel featuring 8% Cobalt
 Tougher tooth design manufactured with M42 Superior Steel featuring 8% Cobalt provides excellent wear resistance properties at higher drilling temperatures giving extended tool life

C Variable Pitch Cutting Teeth
 Variable Pitch Cutting Teeth combine an aggressive cut and increased spoil removal with a smoother cut and reduced vibration for increased speed and tool durability

D Irregular Depth Clearance Gullets
 Irregular Depth Clearance Gullets avoid trapped spoil by providing a more efficient chip clearance meaning teeth stay sharper for longer

CVP can be used in:

- Steel
- Stainless steel
- Non-ferrous
- Wood
- Plastics
- MDF

CVP is ideal when working on:

- Metal enclosures, trunking, cabinets, cladding, switchgear (especially stainless steel)
- Woodwork
- Formica
- Panelling



DID YOU KNOW?

M42 Steel (8% Cobalt) has excellent "hot hardness" properties. Therefore the cutting teeth don't wear as quickly as other lower grades of HSS when working at higher temperatures



TECH TIP!

Our holesaws fit standard adaptors - see page 79 for a tip on how to correctly fit your holesaw to your adaptor

CVP - Cobalt Vari-Pitch Holesaws

Diameter Size mm	Overall Length mm	Working Length mm	Technical / Product Detail Drive Arbors mm	Part Number
16	50	38	Use with 14 - 29mm arbor	PCH016
20	50	38		PCH020
22	50	38		PCH022
25	50	38		PCH025
32	50	38		PCH032
35	50	38		PCH035
38	50	38		PCH038
40	50	38		PCH040
44	42	38		PCH044
51	42	38		PCH051
54	42	38	PCH054	
57	42	38	PCH057	
60	42	38	PCH060	
64	42	38	Use with 32 - 152mm arbor	PCH064
65	42	38		PCH065
67	42	38		PCH067
70	42	38		PCH070
73	42	38		PCH073
76	42	38		PCH076
79	42	38		PCH079
83	42	38		PCH083
86	42	38		PCH086
89	42	38		PCH089
95	42	38		PCH095
102	42	38		PCH102
111	42	38		PCH111
114	42	38		PCH114
127	42	38		PCH127
152	42	38	PCH152	



Operation Speed Chart

Diameter Size mm	Mild Steel RPM	Tool Steel or Stainless Steel RPM	Aluminium RPM	Cast Iron RPM	Brass RPM	Wood RPM
20	425	210	635	280	560	3000
25	350	175	525	235	470	2700
32	275	140	410	180	360	2400

Please visit www.armeg.co.uk for full operation speed chart



Please refer to data table for relevant adaptors



When drilling steel



Please refer to data table for relevant adaptors

Have you tried? **Acceler8%**



Also features 8% Cobalt but is designed for extreme speed See page 73

Perfect for.....

A great value holesaw with multiple material drilling capability



- A** Standard Holesaw thread patterns for convenient use with industry standard drive arbors
- B** Slotted body design allows for removal of awkward material slugs for faster repeat hole drilling
- C** Off-Set tooth design creates clearance and minimises the chances of "jamming" or "snagging" in materials being drilled
- D** Bi-Metallic material structure featuring HSS material tooth specification for greater durability

Bi-Metallic Holesaws can be used in:

- Steel
- Stainless steel
- Non-ferrous
- Wood
- Plastics

Bi-Metallic Holesaws are ideal when working on:

- Metal enclosures, trunking, cabinets, cladding, switchgear
- Woodwork
- Formica
- Panelling



DID YOU KNOW?



Our Bi-Metallic Holesaws are available in a purpose designed Electricians kit



TECH TIP!

Our holesaws fit standard adaptors - see page 79 for a tip on how to correctly fit your holesaw to your adaptor

Bi-Metallic HSS Holesaw

Diameter Size mm	Overall Length mm	Working Length mm	Technical / Product Detail Driver Arbors mm	Part Number	
16	50	38	Use with 12 -29mm arbor	CH016	
20	50	38		CH020	
22	50	38		CH022	
25	50	38		CH025	
29	40	38		CH029	
32	50	38		CH032	
38	42	38		CH038	
40	42	38		CH040	
44	42	38		CH044	
46	42	38		CH046	
50	42	38	Use with 32 - 152mm arbor	CH050	
51	42	38		CH051	
57	42	38		CH057	
60	42	38		CH060	
64	42	38		CH064	
65	42	38		CH065	
67	42	38		CH067	
70	42	38		CH070	
73	42	38		CH073	
76	42	38		CH076	
79	42	38	CH079		
83	42	38	CH083		
86	42	38	CH086		
89	42	38	CH089		
92	42	38	CH092		
102	42	38	CH102		
105	42	38	CH105		
111	42	38	CH111		
114	42	38	CH114		
121	42	38	CH121		
127	42	38	CH127		
152	42	38	CH152		

Sets	Set Contents	Part Number	
5 Piece Electricians Set	1 X 20 / 25 / 32 / 64 / 73mm 1 X 9.5mm Hexagon Shank Arbor 1 X 13mm Hexagon Shank Arbor	CH6SETELHEX	

Operation Speed Chart

Diameter Size mm	Mild Steel RPM	Free-Cutting Stainless Steel RPM	Aluminium RPM	Grey Cast Iron RPM	Brass RPM	Wood RPM
20	425	210	280	635	560	3000
25	350	175	235	525	470	2700
32	275	140	180	410	360	2400

Please visit www.armeg.co.uk for full operation speed chart



Please refer to data table for relevant adaptors



When drilling steel



Please refer to data table for relevant adaptors

Have you tried?
Cobalt Vari-Pitch Holesaws



Our range of CVP's offer a premium alternative with greater product performance & durability See page 75

TECH TIP!

Check out our Holesaw Assembly Guide Below for fitting adaptors to holesaws sized 32mm+



Take the adaptor and turn the knurled ring anti-clockwise to retract the drive pins into the position shown.

Screw the desired holesaw onto the adaptor until its finger tight.



On the back plate of the holesaw are 4 drive pin location holes situated around the adaptor screw thread hole. The hole saw should be 'backed off' until the first pair of drive pin location holes line up with the adaptor drive pins.



Screw the knurled ring clockwise to locate adaptor drive pins into the holes on the back of the holesaw. Notice the gap between the holesaw and the adaptor. This is necessary to prevent the holesaw locking onto the adaptor during the drilling process.

1

In this example, when the adaptor is tightened onto the holesaw fully, the drive pins end up where the dotted line are

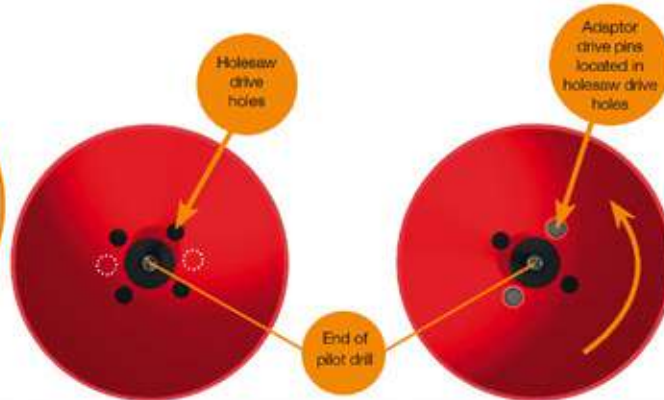

2

If the holesaw is turned in the direction of the arrow, the drive pins can be located in the first pair of drive holes they arrive at.

TECH TIP!

For holesaw sizes 19-24mm both holesaw and adaptor have spanner flats to aid disassembly

Holesaw Accessories

Description	Suitable for Size	Shank	Thread	Grub Screw	Part Number	
9.5mm Hexagon Shank Drive Arbor	14 - 29mm		1/2" - 20 (U.N.F)	M8x6	CHD16-29HEX	
SDS Plus Shank Drive Arbor	14 - 29mm		1/2" - 20 (U.N.F)	M8x6	CHD16-29SDS	
13mm Hexagon Shank Drive Arbor	32 - 152mm		5/7" - 18 (U.N.F)	M8x14	CHD32-64HEX	
SDS Plus Shank Drive Arbor	32 - 152mm		5/8" - 18 (U.N.F)	M8x14	CHD32-64SDS	

Description	Diameter (mm)	Overall Length (mm)	Working Length (mm)	Technical Details	Part Number	
Holesaw Pilot Drill	1/4"	74	35	Flute ground, HSS Pilot drill suitable for all holesaws	CHPD	

Have you tried?
Our holesaw accessories are ideal when using:



CVP Holesaws
Bi-Metallic Holesaws
Soil Pipe Chamfering Tool

Page 75
 Page 77
 Page 145



Perfect for..... Features Armeg's impact rated premium quality drill bits, ideal for tradesmen using impact drivers



A Twister HSS Cobalt Drill Bits
Featuring 5% cobalt for increased wear resistance and extended durability



B Twister Masonry Drill Bits
1 piece design made from high quality steel for optimum performance in impact drivers



C Nail-Proof Stubby Woodbeaver
The solution to drilling in nail embedded wood, with a compact length ideal for inter-joint drilling



D Acceler8%
Designed specifically for drilling sheet steel, Acceler8% is built for speed



E 230mm Long 1/4" Extension Rod
Quick-Change extension rod, perfect for when extra reach is required



F SDS Plus to 1/4" Adaptor
Quick-Change adaptor converts 1/4" shank accessories to SDS Plus compatibility for machine versatility



TECH TIP!

Try not to strike the surface of the drilled material with the quick-change mechanism as this will disengage the drill bit

Scan me for demo video



Multi Material Drilling Set is ideal for use with:

- Masonry
- Metal
- Wood

16 Piece Twister Drilling Set

Description	Set Contents	Part Number
16 Piece Twister Drilling Set	<p>Nail-Proof Stubby WoodBeaver 1 x 20, 25mm</p> <p>Acceler8% 1 x 20, 25, 32mm</p> <p>Twister Masonry 2 x 5.5 x 150mm 1 x 6.0 x 150mm 1 x 7.0 x 150mm 1 x 8.0 x 150mm</p> <p>Twister HSS Cobalt 1 x 3.0, 4.0, 5.0, 6.0mm</p> <p>Accessories 1 x Quick-Change SDS Plus to 1/4" Adaptor 1 x Quick-Change 1/4" Extension Rod</p>	<p>TW16PCSET</p> 

DRILL. WITH IMPACT.



IT'S ALL ABOUT THE TORSION.

When an impact driver faces enough resistance during drilling the machine delivers fast and powerful torsional impacts.

NOT ALL 1/4" SHANKS ARE CREATED EQUAL.

We only give our give our Twister impact Rated seal of approval to tools which can withstand this higher torque and offer the performance and durability required in impact drivers.

DID YOU KNOW?

All shanks are manufactured to ISO Standard ISO 1173:200



1/4" Shank



When used with the relevant adaptor



Have you tried?
Our Twister Drill Set Products:



- Nail-Proof WoodBeaver**
- Twister Masonry**
- Acceler8%**
- SDS Plus Quick-Change Adaptor & 1/4" Quick-Change Extension Rod**

- Page 57
- Page 25
- Page 73
- Page 58



Page
85



HSS Flute Ground 135° Split Point Drill Bits

High performance option for instant start up, accuracy and durability

Page
87



HSS Jobber Drill Bits – Imperial and Metric

A great general purpose metal cutting drill bit

Page
90



HSS Jobber Drill Bits – Long Series

Longer length Jobber Drill Bits for greater working lengths and versatility

Page
91



HSS Blacksmith Drill Bits

Reduced shanks to fit 1/2" 3 Jaw Chucks

Material	HSS 135° Split Point	HSS Jobber Drill Bits	HSS Jobber Drill Bits- Long Series	HSS Blacksmith Drill Bits
Mild Steel	●	●	●	●
Stainless Steel	●	●	●	●
Cast Iron	●	●	●	●
Aluminium	●	●	●	●
Brass	●	●	●	●
Wood	●	●	●	●
Plastic	●	●	●	●

- Very suitable
- Suitable
- Suitable but better alternative
- Not suitable

Product selector...

Simply choose the material you need to drill and use our rating guide to choose which is the best tool for you.

Our metal drill bit range has metal drilling perfectly covered. Offering a variety of options from standard jobber drill bits to the high performance 135° Split Point design, large diameter ranges, imperial sizes and longer length versions, we offer a solution to your metal drilling needs.

Perfect for.....
Instant start-up, accuracy
and durability



A

- A Flute Ground** for greater accuracy
- B Purpose Designed 135° Angle Geometry** at the end of the drill bit is perfect for drilling in sheet materials
- C Split Point Design** helps to centre the drill accurately and reduce wander
- D Ideal Combination of 135° angle** and split point design improves penetration rates for faster drilling

HSS 135° Split Points can be used in:

- Steel
- Non-ferrous
- Wood
- Plastics

HSS 135° Split Points are ideal for:

- Fixing holes
- Tapping & clearance holes
- Great when working in:
 - Automotive maintenance
 - Light engineering
 - Workshops
 - Plumbing & electrical applications

DID YOU KNOW?

A split point is an extra facet ground on to the end of the drill bit causing it to be more pointed rather than having a straight edge – this helps to centre the drill bit and reduce wander

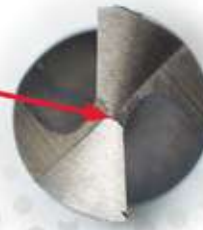

HSS Split Point



Standard HSS



135°

- D
- C
- B

DID YOU KNOW?

Our HSS 135° Split points are manufactured to Din Standard 338

TECH TIP!

Our HSS Split Point drills can be re-sharpened for longer life (providing the drill bit has not been over heated in use)

HSS Flute Ground 135° Split Point Drill Bits

Diameter Size mm	Overall Length mm	Working Length mm	Singles	Part Number Packs of 5	Packs of 10
1.0	34	12	YMSP0100W	-	YMSP0100L
1.5	40	18	YMSP0150W	-	YMSP0150L
2.0	49	24	YMSP0200W	-	YMSP0200L
2.5	57	30	YMSP0250W	-	YMSP0250L
3.0	61	33	YMSP0300W	-	YMSP0300L
3.3	65	36	YMSP0330W	-	YMSP0330L
3.5	70	39	YMSP0350W	-	YMSP0350L
4.0	75	43	YMSP0400W	-	YMSP0400L
4.2	75	43	YMSP0420W	-	YMSP0420L
4.5	80	47	YMSP0450W	-	YMSP0450L
5.0	86	52	YMSP0500W	-	YMSP0500L
5.5	93	57	YMSP0550W	-	YMSP0550L
6.0	93	57	YMSP0600W	-	YMSP0600L
6.5	101	63	YMSP0650W	-	YMSP0650L
7.0	109	69	YMSP0700W	-	YMSP0700L
7.5	109	69	YMSP0750W	-	YMSP0750L
8.0	117	75	YMSP0800W	-	YMSP0800L
8.5	117	75	YMSP0850W	-	YMSP0850L
9.0	125	81	YMSP0900W	-	YMSP0900L
10.0	133	87	YMSP1000W	-	YMSP1000L
10.5	133	87	YMSP1050W	YMSP1050L	-
11.0	142	94	YMSP1100W	YMSP1100L	-
12.0	151	101	YMSP1200W	YMSP1200L	-
12.5	151	101	YMSP1250W	YMSP1250L	-
13.0	151	101	YMSP1300W	YMSP1300L	-



Operation Speed Chart

Diameter Size mm	Mild Steel RPM	Free-Cutting Stainless Steel RPM	Grey Cast Iron RPM	Aluminium RPM	Copper RPM	Brass RPM
2	3501	2228	5252	6366	6366	6366
4	1751	1114	2626	3183	3183	3183
6	1167	743	1751	2122	2122	2122
8	875	557	1313	1592	1592	1592
10	700	446	1050	1273	1273	1273
13	539	343	808	979	979	979

Please visit www.armeg.co.uk for full operation speed chart



When drilling steel and alloys

Have you tried?
HSS Jobber Drill Bits



Our range of HSS Jobber drill bits offer a value alternative when a more general purpose drill bit is required. See page 87

Perfect for.....
A great general purpose metal cutting drill bit



- A Full Range** of diameters from 1.0 to 13.0 in 0.5mm increments for flexibility to cover a broad range of applications
- B Roll-Forged Flutes** rapidly remove spoil for progressive drilling actions
- C Ideal Performance** in steel and cast materials to 580 H/mm²
- D Optimal 118°** grinding processes ensure drill balance, reliable performance and hole tolerance. The tip angle also ensures the HSS Jobber Bits are versatile for a variety of applications and materials.
- E Steam Tempered** to improve durability

HSS Jobbers can be used in:

- Steel
- Non-ferrous
- Wood
- Plastics

DID YOU KNOW?

Our HSS Jobbers are available in metric, imperial, sets and longer length varieties



118°

D

DID YOU KNOW?

Roll-Forged bits are twisted when forged in the manufacturing process. This causes the molecular structure of the steel to follow the flute giving good durability

HSS Jobbers are ideal for:

- Fixing holes
- Tapping & clearance holes
- Great when working in:
 - Automotive maintenance
 - Light engineering
 - Workshops
 - Plumbing & electrical applications



Available in 7, 19, & 25 Piece sets

HSS Roll-Forged Jobber Drill Bits - Metric Range

Diameter Size mm	Overall Length mm	Working Length mm	Singles	Part Number Packs of 5	Packs of 10
1.0	34	12	YM0100W	-	YM0100L
1.5	40	18	YM0150W	-	YM0150L
2.0	49	24	YM0200W	-	YM0200L
2.5	57	30	YM0250W	-	YM0250L
3.0	61	33	YM0300W	-	YM0300L
3.3	65	36	YM0330W	-	YM0330L
3.5	70	39	YM0350W	-	YM0350L
4.0	75	43	YM0400W	-	YM0400L
4.2	75	43	YM0420W	-	YM0420L
4.5	80	47	YM0450W	-	YM0450L
5.0	86	52	YM0500W	-	YM0500L
5.5	93	57	YM0550W	-	YM0550L
6.0	93	57	YM0600W	-	YM0600L
6.5	101	63	YM0650W	-	YM0650L
7.0	109	69	YM0700W	-	YM0700L
7.5	109	69	YM0750W	-	YM0750L
8.0	117	75	YM0800W	-	YM0800L
8.5	117	75	YM0850W	-	YM0850L
9.0	125	81	YM0900W	-	YM0900L
9.5	125	81	YM0950W	-	YM0950L
10.0	133	87	YM1000W	-	YM1000L
10.5	133	87	YM1050W	YM1050L	-
11.0	142	94	YM1100W	YM1100L	-
11.5	142	94	YM1150W	YM1150L	-
12.0	151	101	YM1200W	YM1200L	-
12.5	151	101	YM1250W	YM1250L	-
13.0	151	101	YM1300W	YM1300L	-



Sets	Set Contents	Part Number
7 Piece	1.5, 2.0, 3.0, 4.0, 5.0, 5.5, 6.0mm	YMSET7
19 Piece	1 - 10mm in 0.5mm increments	YMSET19
25 Piece	1 - 13mm in 0.5mm increments	YMSET25



Operation Speed Chart

Diameter Size mm	Mild Steel RPM	Free-Cutting Stainless Steel RPM	Grey Cast Iron RPM	Aluminium RPM	Copper RPM	Brass RPM
2	3501	2228	5252	6366	6366	6366
4	1751	1114	2626	3183	3183	3183
6	1167	743	1751	2122	2122	2122
8	875	557	1313	1592	1592	1592
10	700	446	1050	1273	1273	1273
13	539	343	808	979	979	979

Please visit www.armeg.com for full operation speed chart

Turn over for Imperial & Long Series ranges



When drilling steel and alloys

Have you tried?
HSS 135° Split Point Drill Bits



Trade up to our premium HSS 135° split point drill bits when high usage applications are involved See page 85

HSS Roll-Forged Jobber Drill Bits - Imperial Range

Diameter Size inch	Overall Length mm	Working Length mm	Singles	Part Number Packs of 5	Packs of 10
1/16"	48	22	YB0010W	-	YB0010L
5/64"	51	25	YB0020W	-	YB0020L
3/32"	57	32	YB0030W	-	YB0030L
7/64"	67	38	YB0040W	-	YB0040L
1/8"	70	41	YB0050W	-	YB0050L
9/64"	76	48	YB0060W	-	YB0060L
5/32"	79	51	YB0070W	-	YB0070L
11/64"	83	54	YB0080W	-	YB0080L
3/16"	89	59	YB0090W	-	YB0090L
13/64"	92	62	YB0100W	-	YB0100L
7/32"	95	64	YB0110W	-	YB0110L
15/64"	98	67	YB0120W	-	YB0120L
1/4"	102	70	YB0130W	-	YB0130L
17/64"	105	73	YB0140W	-	YB0140L
9/32"	108	75	YB0150W	-	YB0150L
19/64"	111	78	YB0160W	-	YB0160L
5/16"	114	81	YB0170W	-	YB0170L
21/64"	117	84	YB0180W	-	YB0180L
11/32"	121	87	YB0190W	-	YB0190L
23/64"	124	89	YB0200W	-	YB0200L
3/8"	127	92	YB0210W	-	YB0210L
25/64"	130	95	YB0220W	YB0220L	-
13/32"	133	98	YB0230W	YB0230L	-
27/64"	140	103	YB0240W	YB0240L	-
7/16"	143	106	YB0250W	YB0250L	-
29/64"	143	106	YB0260W	YB0260L	-
15/32"	146	110	YB0270W	YB0270L	-
31/64"	152	114	YB0280W	YB0280L	-
1/2"	152	114	YB0290W	YB0290L	-



Operation Speed Chart

Diameter Size inch	Decimal	Mild Steel RPM	Free-Cutting Stainless Steel RPM	Grey Cast Iron RPM	Aluminium RPM	Copper RPM	Brass RPM
5/64"	0.0781	3585	2305	4609	6658	6658	6658
1/8"	0.1250	2240	1440	2880	4160	4160	4160
3/16"	0.1875	1493	960	1920	2773	2773	2773
1/4"	0.2500	1120	720	1440	2080	2080	2080
3/8"	0.3750	747	480	960	1387	1387	1387
1/2"	0.5000	560	360	720	1040	1040	1040

Please visit www.armeg.co.uk for full operation speed chart



When drilling steel and alloys

Perfect for.....

Longer length HSS Jobbers are ideal for drilling deeper holes or where extended reach is required



Long Series HSS Roll-Forged Jobber Drill Bits

Diameter Size mm	Overall Length mm	Working Length mm	Singles	Part Number Packs of 5	Packs of 10
3.0	100	66	-	-	YM0300LLS
4.0	119	78	-	-	YM0400LLS
4.5	126	82	-	-	YM0450LLS
5.0	132	87	-	-	YM0500LLS
6.0	139	91	-	-	YM0600LLS
8.0	165	109	-	-	YM0800LLS

Operation Speed Chart

Diameter Size mm	Mild Steel RPM	Free-Cutting Stainless Steel RPM	Grey Cast Iron RPM	Aluminium RPM	Copper RPM	Brass RPM
3	1804	1273	2653	3183	3183	3183
4	1353	955	1989	2387	2387	2387
5	1082	764	1592	1910	1910	1910
6	902	637	1326	1592	1592	1592
8	676	477	995	1194	1194	1194

Please visit www.armeg.co.uk for full operation speed chart



When drilling steel and alloys

Perfect for.....
Producing large diameter holes from 14 - 22mm with a solid fluted drill bit



- A Reduced 1/2" Shank**
 Reduced 1/2" shank means drill bits larger than 14mm can be used in 1/2" capacity power tool chucks
- B Solid Drill Bit**
 When large diameters need drilling with solid drill bits, the blacksmith range is purpose designed for the job
- C Steam Tempered Finish**
 Steam tempered as part of heat treatment process for extra durability
- D 118° Point**
 Optimal 118° grinding processes ensure drill balance, reliable performance and hole tolerance

Blacksmith Drill Bits can be used in:

- Steel
- Non-Ferrous
- Wood
- Plastics



DID YOU KNOW?

Blacksmith drill bits are ideal for large diameter metal drilling when longer reach or increased depth of cut is required or occasions where existing holes need enlarging

Reduced shank is ideal for fitting into hand held power tools

Blacksmith Drills are ideal when working in:

- Engineering workshops, automotive maintenance, fabrication etc.

HSS Blacksmith Drill Bits

Diameter Size mm	Overall Length mm	Working Length mm	Part Number
14	159	83	YBS1400X156
15	159	83	YBS1500X156
16	159	83	YBS1600X156
18	159	83	YBS1800X156
19	159	83	YBS1900X156
20	159	83	YBS2000X156
22	159	83	YBS2200X156



Operation Speed Chart

Diameter Size mm	Mild Steel RPM	Free-Cutting Stainless Steel RPM	Grey Cast Iron RPM	Aluminium RPM	Copper RPM	Brass RPM
14	500	318	750	909	909	909
18	389	248	584	707	707	707
22	318	203	477	579	579	579

Please visit www.armeg.co.uk for full operation speed chart



Min Chuck Requirement 13mm



When drilling steel and alloys

Have you tried?
Cobalt Vari-Pitch Holesaws



Perfect for when a holesaw is preferable over a solid fluted drill bit See page 75



Page
95



PTC – Diamond Crown Porcelain Tile Drills

The ultimate in durability for small and large diameter holes in porcelain tiles

Page
99



PTC – Carbide Tipped Porcelain Tile Drill Bits

The fastest, simplest solution for small diameter holes – simply push, cool and drill

Page
101



PTC – Tile Drilling Accessories

Everything required to ensure our tile drilling systems are driven, cooled and accurately located

Page
103



Diamond Grit Tile Drills

Provides an excellent balance between speed of cut and durability

Page
105



Soft Tile Drill Bits

Perfect for softer tiles and more occasional hole drilling in tile

Page
107



Tile Cutting Diamond Blades & Accessories

The most popular sizes for cutting tiles available in two performance levels

Material	PTC Diamond Crown	PTC Carbide	Diamond Grit	Soft Tile	Premium Diamond Blades	a-line Diamond Blades
Plaster-backed wall tiles	●	●	●	●	●	●
Ceramic	●	●	●	●	●	●
Natural Slate	●	●	●	●	●	●
Travertine	●	●	●	●	●	●
Marble	●	●	●	●	●	●
Granite	●	●	●	●	●	●
Quarry Tiles	●	●	●	●	●	●
Porcelain	●	●	●	■	●	●

Product selector...

Simply choose the material you need to drill and use our rating guide to choose which is the best tool for you.

Tiles come in many different grades and levels of toughness, so when it comes to drilling them, you need options. The 4 key tile drilling ranges which Armeg offer cover all bases brilliantly. Whether its soft plaster backed tiles, right up to the toughest grade 5 porcelain tiles, Armeg have the answer to speed, durability, accuracy and convenience.

- Very suitable
- Suitable
- Suitable but better alternative
- Not suitable

Perfect for.....

Ultimate durability for small and large diameter holes in porcelain tiles

Small Diamond Crown sizes 6 to 10mm



A 10mm Hexagon Shank

For direct fitting in to drill chucks and guaranteed non-slip action

B Core Ejection Slot

Provides easy and hassle free extraction of tile slugs from the slug chamber

C Extreme Crown & Body Bond

The diamond crown is bonded to the steel body with a copper braze heated at over 600°C to create an extreme bond for extreme durability

D 3mm Deep Diamond Crown Segment

The combination of ultra hard segment and diamond grains combine to rapidly cut through porcelain tiles with an abrasive action

E Thin Wall 2 Piece Diamond Segment

The thin wall profile reduces the 'drag' when drilling in tiles leading to faster tile penetration and easier tile slug removal

TECH TIP!

Water cooling is required when drilling porcelain tiles. See pages 101 and 102 for water delivery systems

Piloting method for Small Diamond Crowns



Mark the position of the desired hole



Stick the guide pad onto the clean, dry tile. The corresponding size hole to the diamond crown should be selected in line with the mark



Enter the diamond crown into the hole in the guide pad. Ensure a flow of cool water to the diamond crown and commence drilling

Large Diamond Crown sizes 13 to 58mm



A Spanner Flats

Spanner flats precision machined on all crown bodies aid simple and rapid disassembly of crowns from adaptors for user convenience

B Fully 'Heat Treated' Alloy Steel Body

Fully 'heat treated' 34CrNiMo6 alloy steel body provides a durable construction which can withstand intensive use for consistently reliable performance

C Extreme Crown & Body Bond

The diamond crown is bonded to the steel body with a copper braze heated at over 600°C to create an extreme bond for extreme durability

D 5mm Deep Diamond Crown Segment

The combination of ultra hard segment and diamond grains combine to rapidly cut through porcelain tiles with an abrasive action

E Thin Wall Continuous Diamond Segment

The thin wall profile reduces the 'drag' when drilling in tiles leading to faster tile penetration and easier tile slug removal

Piloting method for Large Diamond Crowns



Drill an 8mm Pilot Hole at the centre position. PTC Carbide is shown but the hole can also be formed with Diamond Grit tile drills or PTC Small Diamond Crowns



8mm Pilot Hole



Start the water flow, enter the pilot into the pre-drilled hole and commence drilling

Scan me for demo video





Diamond Crowns can be used in:

- Plaster-backed wall tiles
- Ceramic
- Natural slate
- Travertine
- Marble
- Granite
- Quarry tiles
- Porcelain

Diamond Crowns are ideal when drilling holes in tile for:

- Waste pipe exits
- Water feed pipes
- Fixing holes
- Shower mixers
- Flue passage
- Extractor fans
- Cable entry / exit



DID YOU KNOW?

Large diameter designs are tested to over 500 holes without failure in grade 5 porcelain tiles

TECH TIP!

Water cooling is required when drilling porcelain tiles. See page 101 for water delivery systems and adaptors

TECH TIP!

A slight 'rocking' motion is advisable when using PTC diamond. This improves water flow to the cutting edge. It also makes the 'slug' of tile smaller than the bore of the cutter which facilitates slug removal

Small Diameter Crowns 6 to 10mm

Diameter Size mm	Overall Length mm	Working Length mm	Max. Recommended Tile Thickness	Part Number
6.0	55	20	20 (wear)	PTC06.0CRM
6.5	55	20	20 (wear)	PTC06.5CRM
7.0	55	20	20 (wear)	PTC07.0CRM
8.0	60	20	20 (wear)	PTC08.0CRM
10.0	65	25	25 (wear)	PTC10.0CRM



All Diamond Crowns are supplied with the equivalent size Masonry Drill Bit to complete the drilling of supporting substrates to enable fixing installation

Large Diameter Crowns 13 to 58mm

Diameter Size mm	Overall Length mm	Working Length mm	Max. Recommended Tile Thickness	Part Number
13	40	21-25	21-25 (wear)	PTC13CR
19	40	21-25	21-25 (wear)	PTC19CR
26	40	21-25	21-25 (wear)	PTC26CR
36	40	21-25	21-25 (wear)	PTC36CR
44	40	21-25	21-25 (wear)	PTC44CR
58	40	21-25	21-25 (wear)	PTC58CR



Please see page 101 for water delivery solutions and adaptors.

PTC Diamond Crowns can be used at any speed up to approximately 1800 r.p.m. Ideally 1000 r.p.m gives you the perfect combination of rapid progress and adequate water cooling



No impact / percussion should be used



When used with relevant adaptor and 3 Jaw Chuck, no impact



1/2" U.N.F



Water or suitable coolant should always be used



13mm Crown 15mm
19mm Crown 17mm
26 - 58mm Crowns 21mm

Have you tried?
Diamond Grit Drills



Offer a value alternative but with reduced product durability See page 103



Perfect for.....
The fastest, simplest solution for small diameter holes - simply push, cool and drill

- A Purpose Designed Tip Tolerances**
 Holes are produced slightly oversized in the tile. Allows fixings to be secured and expanded in the material behind the tile, not on the tile edge itself, reducing the risk of cracked tiles
- B P100 Grade Tungsten Carbide Tip**
 P100 grade tungsten carbide tip provides durability when drilling in the hardest of tile materials
- C Unique Head Geometry**
 Unique geometry of the cutting head allows the drill bit to rapidly cut through the materials without burning or glazing the tile
- D Diamond Ground 'Drill Tip'**
 4 unique grinds to the top of the drill tip mean the drill 'bites' into the tile providing a 'point & push' start up with no leaning in required and no wander on the tile. Accurate holes are produced exactly where required.

PTC Carbide can be used in:

- Plaster-backed wall tiles
- Ceramic
- Natural slate
- Travertine
- Marble
- Granite
- Quarry tiles
- Porcelain

PTC Carbide is ideal when drilling holes in tile for:

- Fixing holes



PTC Carbide shown with water cooling system, quickly producing a hole in porcelain tile



A hole is being produced in the substrate behind the tile with a suitable drill bit for the material being drilled



A fixing hole is formed quickly in any type of tile

DID YOU KNOW?

PTC Carbide has been



since 2003 & produced to Armeg's own in-house designs. PTC Carbide revolutionised the porcelain tile drilling industry, giving tradesman a solution to drilling previously 'un-drillable' tiles

TECH TIP!

Water cooling is required when drilling porcelain tiles. See page 101 for water delivery systems and adaptors for use with PTC Carbide

Scan me for demo video



PTC Carbide - Straight Shank

Diameter Size mm	Overall Length mm	Working Length mm	Max. Recommended Tile Thickness	Part Number
5.0	113	13	6.0	CTCP5.0
6.0	113	13	7.75	CTCP6.0
6.5	113	13	8.0	CTCP6.5
7.0	113	13	9.25	CTCP7.0
8.0	113	13	11.5	CTCP8.0
10.0	113	13	13.0	CTCP10.0



PTC Carbide Drill Bits are supplied with the equivalent size masonry drill bit

PTC Carbide - Straight Shank Multi-Packs

Diameter Size mm	Overall Length mm	Working Length mm	Max. Recommended Tile Thickness	Part Number
5.0	113	13	6.0	CTCSET5.0
6.0	113	13	7.75	CTCSET6.0
6.5	113	13	8.0	CTCSET6.5
7.0	113	13	9.25	CTCSET7.0
8.0	113	13	11.5	CTCSET8.0
10.0	113	13	13.0	CTCSET10.0



PTC Carbide Multi-Packs contain 4 X PTC Carbide drill (in chosen diameter), plus 1 X equivalent size masonry drill bit

PTC Carbide - SDS Plus Shank

Diameter Size mm	Overall Length mm	Working Length mm	Max. Recommended Tile Thickness	Part Number
6.0	113	13	7.75	CTCS6.0
7.0	113	13	9.25	CTCS7.0
8.0	113	13	11.5	CTCS8.0



SDS Plus Shank PTC Carbide Drill Bits are supplied with the equivalent size SDS Plus hammer drill bit

*Please see page 99 for required water delivery solutions & adaptors

PTC Carbide should be used as close to 900 r.p.m as possible. The further you stray away from this speed in either direction, the quicker the drill will wear out

TECH TIP!

PTC Carbide can be used in softer tile (e.g. plaster-backed ceramic wall tile) when their useful life is exhausted in hard tiles such as porcelain



No impact / percussion should be used



When used with relevant adaptor and 3 Jaw Chuck, no impact



Water or suitable coolant should always be used

Have you tried?
PTC Diamond Crowns



Offer an extended life option, perfect for applications that require many repeat holes drilling See page 95

Perfect for.....

Everything required to ensure our tile drilling systems are driven, cooled and accurately located

Water Delivery System



All PTC tools utilise Armeg's water feed pressure pump to ensure an effective and continuous flow of water to the cutting edge

PTC - Large Diamond Crown Drilling Accessories & Water Delivery



Features an integral attachment which the Water Feed Pressure Pump Pipe slots into. Water coolant is then driven internally to the Large Diamond Crown and directly to the cutting edge

Diamond Crown Adaptor Usage Diagram



DID YOU KNOW?

When using the PTCPAD adaptor with Large Diameter Crowns the guide rod will fit securely into an 8mm pilot hole for non-slip start up and accurate hole location

TECH TIP!

1 or 2 pumps on the Water Feed Pump handle should be sufficient for most applications and should avoid excessive amounts of water being used

TECH TIP!

The Diamond Crown Guide Pads are only designed to be used once and should be disposed of after use. When using the Guide Pads, make sure the tile is clean and dry for better adhesion

PTC Tile Drilling Accessories

Description	Technical Information	Part Number	
PTC Water Feed Pump		PTCWFKIT	
Water Feed Unit	Suitable for all diameters of PTC Small Diamond Crown and Diamond Grit Tile Drill	DGTDWF5-35	
PTC Drive Adaptor (13 - 58mm Crowns)	Drive adaptor for PTC Diamond Crown Drills 13 - 58mm	PTCPAD	
PTC Guide Pad Multi-Pack x 25 (6 - 10mm Crowns)	Adhesive guide pads for PTC Diamond Crown Drills 6 - 10mm	PTCMULTIGP25	
PTC Guide Pad Multi-Pack x 100 (6 - 10mm Crowns)	Adhesive guide pads for PTC Diamond Crown Drills 6 - 10mm	PTCMULTIGP100	



1/2" U.N.F

Perfect for.....
Provides an excellent balance
between speed of cut & durability



- A Stubby Body Design**
 Stubby body design provides a direct fitting into power tools with no requirement for drive adaptors for user convenience
- B Fully Hardened Carbon Steel**
 Fully hardened carbon steel body ensures a robust, durable and long lasting tool
- C Core Ejection Slot**
 Core ejection slot provides easy and hassle free extraction of tile slugs
- D Reverse Spiral Design**
 Reverse spiral design channels cool water to the drilling edge to effectively increase tool life
- E High Quality Industrial Diamond**
 High quality diamond grit is bonded to the cutting edge providing an abrasive cutting action for rapid and smooth drilling
- F Raised Diamond Drill Lip**
 Raised diamond drill lip assists 'starting off' helping minimise skating and tile damage

Diamond Grit Tile Drills can be used in:

- Plaster-backed wall tiles
- Ceramic
- Natural slate
- Travertine
- Marble
- Granite
- Quarry tiles
- Porcelain

Diamond Grit Tile Drills are ideal when drilling holes for:

- Waste pipe exits
- Water feed pipes
- Fixing holes
- Cable entry / exit

DID YOU KNOW?

Diamond Grit Tile Drills are often used in domestic applications where occasional holes are required for bathroom installations or upgrades

Diamond Grit Tile Drills are designed to be water cooled to increase tool life



Try the Armeg Water Feed Pump see page 101



Or try the Diamond Grit Water Feed Unit. Provides a water drip feed to Diamond Grit Tile Drills to increase product life

Scan me for demo video



**Perfect for.....
Softer tile drilling and more
occasional hole drilling in tile**



- A** Zinc coated for a rust-proof finish
- B** Point ground tip design provides added grip on start-up to reduce slippage and tile damage
- C** Tungsten carbide tip allows the drill bit to easily penetrate through softer tiles

Soft Tile Drills are ideally designed to be used in:

- Soft tiles
- Ceramic tiles

Soft Tile Drills are great when drilling holes for:

- Fixing holes



DID YOU KNOW?

An extra grind on the point makes our Soft Tile Drill Bits superior than similar products on the market and minimises drill wander enabling easier start-up



Scan me for demo video



Soft Tile Drill Bits

Diameter Size mm	Overall Length mm	Working Length mm	Part Number
5.0	61	15	PST05.0
6.0	63	15	PST06.0
6.5	65	15	PST06.5
7.0	65	15	PST07.0
8.0	70	15	PST08.0
10.0	80	15	PST10.0



All Soft Tile Drill Packs are supplied with 2 X Soft Tile Drill Bits and 1 X equivalent size Masonry Drill Bit

Soft Tile Drill Bits

Description	Contents	Part Number
5 Piece Soft Tile & masonry drill bit set	5 / 6 / 7 / 8 / 10mm (Contains 5 x soft tile drill bits & 5 x masonry drill bits in each size)	PSTSET5



Soft Tile Drills should be used on a fairly slow speed, typically 300-500 r.p.m

TECH TIP!

All our Soft Tile Drills are supplied as a 'start-up' pack, containing 2 X Soft Tile Drill bits, plus the equivalent sized masonry bit for drilling material behind the tile



No impact / percussion should be used



When used with relevant adaptor and 3 Jaw Chuck, no impact

Have you tried?
Diamond Grit Tile Drills



Offer a higher quality solution for longer life whilst being the closest offering in terms of price See page 103

PTC Diamond Blades

a-line Diamond Blades 

Perfect for.....
 The premium option for extreme performance in the hardest of porcelain tile

Perfect for.....
 The value option designed to cover many applications in ceramic and stone tile



- Thin 2.5mm design for rapid cutting
- 10mm high turbo rim diamond segments for extended durability
- Up to twice as fast as other blades

- Continuous diamond rim for smooth, chip free cutting

TECH TIP!

When using Tile Cutting Blades, the cutting should always be done with the edge of the blade as opposed to using the blades like grinding wheels which cut on the surface. Using the blades incorrectly causes the wheel profile to become tapered and can become wedged when cutting

PTC Diamond Blades can be used in:

- The hardest of porcelain tile

a-line Diamond Blades can be used in:

- Ideal for ceramic tiles, but will cut porcelain tiles

Tile Cutting Diamond Blades are great for:

- General tile cutting
- Shaping of tile profiles
- Large hole production

PTC Tile Cutting Diamond Blades

Diameter Size mm	Bore Size mm	Segment Width mm	Segment Height mm	Part Number	
115	22.2	1.2	10mm turbo design	PTCDB115X22.2P	

a-line Tile Cutting Diamond Blades

Diameter Size mm	Bore Size mm	Segment Width mm	Segment Height mm	Part Number	
115	22.2	1.6	10mm continuous rim	PTCDB115X22.2	

Operation Speed Chart

Diameter Size mm	RPM
115	13280

TECH TIP!

Pay close attention to the 'direction arrows' on the blade when mounting on your machine. The direction of the arrow on the blade should correspond with the one on the machine



Can be used with Angle Grinders



Can be used Wet or Dry



Use with tile cutting machines including:
Radial Tile Saws
Overhead Tile Saws
Handheld Tile Saws



SCREWDRIVING

Page
111



Switch-Blade - Interchangeable VDE Screwdriving Range

Features 3 Handles and 23 Blades to provide 69 different drive options

Page
115



GripX² VDE Insulated Screwdrivers

Designed for comfort, precision and safety when working on live connections

Page
117



Twister – Screwdriver Bit Sets & Accessories

Time saving & problem solving range of Screwdriver Bit & Socket Sets

HAND TOOLS

Page
121



VDE Diagonal Side Cutters

Induction hardened for durable sharp edges

Page
123



VDE Combination Pliers

Induction hardened for toughness and durability

Page
125



Cable Cutters

Sharp and strong high performance cable cutters

Page
127



CIR Range – Accessories

A professional range of hand tools to aid conduit installation

SAWING & CUTTING

Page
129



EBS Board Saw

Rapidly produce holes in plaster and dry lining

Page
131



Retractable Utility Knife

Soft grip and non-slip handle

Page
133



Hacksaws & Spare Blades

An assured range of metal cutting saws

TOOL TOTES & KITS

Page
135



Tool Totes

A range of Tool Tote kits perfect for the professional tradesman

ACCESSORIES

Page
137



16oz Claw Hammer

One piece chrome vanadium for strength

Page
139



5m Tape Measure

Nylon coated steel tape for durability

Page
141



Brick Line Runner

The quick and simple way to run a line

Page
143



Wrenches - Jaw Dropper / Grip-Fast / Pipe Chamfering Tools

An innovative collection of smart design wrenches that solve common installation issues

Page
147



Screw Extractors

For removing broken bolts and screws

Page
149



SDS Plus Chuck Adaptors & Socket Drivers

Drive Sockets, Screwdriver Bits and 3 Jaw Chucks in SDS Plus Machines

Armeg's focus on customer needs and accessory requirements in recent years has led to the rapid expansion of smarter drills and also smarter tools. The tool ranges supplied by Armeg follow our principles of being 'smarter' and offer users efficient options often saving time, hassle and money. Our range spans from new application specific problem solvers to traditional hand tools.



Perfect for.....
A flexible range of interchangeable VDE Screwdrivers

The new Switch-Blade range from Armeg is the ultimate interchangeable VDE screwdriving range. Designed for convenience and flexibility, the range features 3 VDE handles and 23 VDE blades which can be interchanged to give 69 different drive options. The fully safety assured range is VDE rated, with all tools being tested up to 10,000V in a water bath to ensure user protection. Plus, the high quality Switch-Blade handles are all designed with a soft grip finish to provide added user comfort.



3 VDE HANDLES
23 VDE BLADES
69 DRIVE OPTIONS

SWITCH
>CLICK<
& DRIVE >>>

Build your own bespoke Switch-Blade set...
Keep your collection in the stylish and durable Switch-Blade tool case. Simply choose your start-up set and top up with individual blades as required.

Contain the VDE Torque Screwdriver

13 PIECE VDE FULLY LOADED SET

The most comprehensive Switch-Blade set, fully loaded with all 3 handles and a selection of 9 blades

Contents:

- 1x 1000V VDE Adjustable Torque Screwdriver Handle
- 1x Torque Adjuster
- 1x 1000V VDE Screwdriver Handle
- 1x 1000V VDE T-Handle
- 9x 1000V VDE Interchangeable Blades (1 each x) PZ1, PZ2, Plus / Minus 1 - PZ/SL, Plus / Minus 2 - PZ/SL, SL3.5, SL4.0, SL5.5, Hex 3mm, Hex 4mm



5 PIECE VDE TORQUE SCREWDRIVER SET

The VDE Torque Screwdriver set comes with the VDE Torque handle, adjuster and 3 popular blades to get you started

Contents:

- 1x 1000V VDE Adjustable Torque Screwdriver Handle
- 1x Torque Adjuster
- 3x 1000V VDE Interchangeable Blades (1 each x) PZ2, Plus / Minus 1 - PZ/SL, Plus / Minus 2 - PZ/SL



8 PIECE VDE HANDLE AND BLADE SET

Ideal for those who love the Switch-Blade concept but don't need a VDE Torque Screwdriver, containing the VDE handle, T-Handle and 6 blades

Contents:

- 1x 1000V VDE Screwdriver Handle
- 1x 1000V VDE T-Handle
- 6x 1000V VDE Interchangeable Blades (1 each x) PZ1, PZ2, Plus / Minus 1 - PZ/SL, Plus / Minus 2 - PZ/SL, SL4.0, SL5.5



5 and 8 piece VDE sets come with empty pre-punched slots designed to allow you to fill up with individual blades and handles to create your own bespoke Switch-Blade set

*VDE Torque Screwdriver is not available as an individual item



1000V VDE ADJUSTABLE TORQUE SCREWDRIVER



*Perfect for.....
Tightening to an installations
required torque*

- A Blade Auto-lock and Retention Design**
Blades simply click into the handle, whilst the quick-release twist mechanism allows them to be quickly and simply removed.
- B User Friendly**
Distinctive white markings and audible clicking sounds allow users to quickly identify and adjust torque levels.
- C 1 - 6Nm Adjustable Torque Feature**
Wide torque range provides increased versatility for different manufacturers requirements. Designed to +/- 6% tolerance for accuracy of torque settings.

Why do you need a VDE Adjustable Torque Screwdriver?

Regulation BS7671:2008 states that "the installation of electrical equipment shall take account of Manufacturers' instructions". To adhere to this regulation, electricians must ensure that during the installation, mains and individual MCB & RCD connections are tightened to the required torque recommended by the manufacturer.



DID YOU KNOW?

Our VDE Adjustable Torque Screwdrivers conform to EN ISO 6789:2003 and each one comes with an individual certificate of calibration

TECH TIP!

Our Torque Screwdriver has to be calibrated either every 12 months or 5000 'clicks' (whichever comes first). To maximise usage before calibration, ensure you only click once when you have tightened your screw to the required torque

TECH TIP!

Store your torque handle at the lowest torque setting after use

Scan me for demo video



Safety Guaranteed ✓

1000V Rated 

VDE/Gs Approved 

IEC 60900 



1000V VDE INTERCHANGEABLE SCREWDRIVER HANDLE

Perfect for.....
Versatility and Convenience



A Designed to work with 23 interchangeable VDE blades the Switch-Blade VDE Handle provides the flexibility to work on a variety of live installation applications with only one handle for a space saving, convenient and cost effective solution.

B 1000V VDE rated and tested for safety assurance when working on live installations.

C Blade auto-lock and quick-release design allows blades to be conveniently and quickly removed from the handle for rapid blade change.



1000V VDE INTERCHANGEABLE T-HANDLE

Perfect for.....
High torque loosening and tightening



A Designed to work with 23 interchangeable VDE blades to allow flexibility when working on a variety of live installation projects.

B Maximized soft grip contact allows comfortable and fatigue free repetitive use.

C 1000V VDE Rated and tested for safety assurance when working on live installations.

Why do you need a VDE T-Handle?

The ergonomic T-Shape design provides more powerful leverage for high torque loosening and tightening of screws.

23
BLADE SIZES
AVAILABLE

DID YOU KNOW?

Our 1000V VDE rated products are tested up to 10,000V in a water bath for assured insulation safety

TECH TIP!

To maintain the VDE rating of the tools, only Armeg VDE interchangeable Screwdriver Blades should be used within the Armeg Switch-Blade handles. A positive connection between blade and handle should be ensured

Our range of Twister impact rated screwdriver bit and socket sets





Have you tried?



Great for using in an Impact driver for general driving work

See page 117

Switch-Blade Range

Description	Contents	Part Number	
13 Piece Fully Loaded VDE Adjustable Torque Screwdriver Set	1 x 1000V VDE Adjustable Torque Screwdriver Handle 1 x Torque Adjuster 1 x Calibration Certificate 1 x 1000V VDE Interchangeable Screwdriver Handle 1 x 1000V VDE Interchangeable T-Handle 9 x 1000V VDE Interchangeable Blades (1 x PZ1, PZ2, Plus / Minus 1 - PZ/SL, Plus / Minus 2 - PZ/SL, SL3.5, SL4.0, SL5.5, Hex 3mm, Hex 4mm)	SDSBSET001FL	
5 Piece VDE Adjustable Torque Screwdriver Set	1 x 1000V VDE Adjustable Torque Screwdriver Handle 1 x Torque Adjuster 1 x Calibration Certificate 3 x 1000V VDE Interchangeable Blades (1 x PZ2, Plus / Minus 1 - PZ/SL, Plus / Minus 2 - PZ/SL)	SDSBSET001	
8 Piece VDE Handle and Blade Set	1 x 1000V VDE Interchangeable Screwdriver Handle 1 x 1000V VDE Interchangeable T-Handle 6 x 1000V VDE Interchangeable Blades (1 x PZ1, PZ2, Plus/Minus 1 - PZ/SL, Plus/Minus 2 - PZ/SL, SL4.0, SL5.5)	SDSBSET002	
1000V VDE Interchangeable Screwdriver Handle		SDHVDE001	
1000V VDE Interchangeable T-Handle		SDHTHA001	
PH1 VDE interchangeable Screwdriver Blade		SDICBPH1	
PH2 VDE interchangeable Screwdriver Blade		SDICBPH2	
Plus/Minus 1 - PZ/SL VDE interchangeable Screwdriver Blade		SDICBPM1	
Plus/Minus 2 - PZ/SL VDE interchangeable Screwdriver Blade		SDICBPM2	
Plus/Minus 1 - PH/SL VDE interchangeable Screwdriver Blade		SDICBPM1PH/SL	
Plus/Minus 2 - PH/SL VDE interchangeable Screwdriver Blade		SDICBPM2PH/SL	
PZ0 VDE interchangeable Screwdriver Blade		SDICBPZ0	
PZ1 VDE interchangeable Screwdriver Blade		SDICBPZ1	
PZ2 VDE interchangeable Screwdriver Blade		SDICBPZ2	
SL2.5 VDE interchangeable Screwdriver Blade		SDICBSL2.5	
SL3.5 VDE interchangeable Screwdriver Blade		SDICBSL3.5	
SL4.0 VDE interchangeable Screwdriver Blade		SDICBSL4.0	
SL5.5 VDE interchangeable Screwdriver Blade		SDICBSL5.5	
SL6.0 VDE interchangeable Screwdriver Blade		SDICBSL6.0	
Hex 3.0mm VDE interchangeable Screwdriver Blade		SDICBH3	
Hex 4.0mm VDE interchangeable Screwdriver Blade		SDICBH4	
Hex 5.0mm VDE interchangeable Screwdriver Blade		SDICBH5	
Torx® 8 VDE interchangeable Screwdriver Blade		SDICBT08	
Torx® 10 VDE interchangeable Screwdriver Blade		SDICBT10	
Torx® 15 VDE interchangeable Screwdriver Blade		SDICBT15	
Torx® 20 VDE interchangeable Screwdriver Blade		SDICBT20	
Torx® 25 VDE interchangeable Screwdriver Blade		SDICBT25	
Torx® 30 VDE interchangeable Screwdriver Blade		SDICBT30	

GRIPX²



Perfect for.....
Comfort, precision and safety
when working on live connections



- A Ergonomically designed comfort-grip handle designed for:**
 - Fatigue-free daily use
 - Non-Slip
 - Maximum Comfort
- B Precision machined Chrome Vanadium Molybdenum steel blade:**
 - Provides extreme screw grip by preventing the blade from 'camming' (slipping) out of the screw, avoiding damage to the blade profile
 - Provides a positive location in the screw head for increased durability.
- C Entirely hardened high quality alloy steel shaft**
 - Gives the product extended life and durability whilst providing an efficient torque transfer

DID YOU KNOW?

The contents in our 7 Piece set have been specifically chosen to include the most popular sizes of Screwdriver, including Plus/Minus 1 & 2 Screwdrivers which are ideal when working on terminal screws

GripX² Screwdrivers are ideal for:

- Live connections
- Tightening / loosening terminal screws
- Removal / Replacement of covers & casings etc
- First-fix
- Switch plate fitting / removal

TECH TIP!

Keep the Screwdriver handle clean. A greasy handle could cause injury from unexpected slippage

GripX² Insulated Screwdrivers

Description	Contents	Part Number
7 Piece 1000V GripX ² Screwdriver Set	SL - 2.5, 4, 5.5 PZ - 1, 2 Plus/Minus (PZ/SL) - 1, 2	SDRSET7A
Plus/Minus 1 - PZ/SL x 80 1000V Insulated VDE Screwdriver		SDRPM1
Plus/Minus 2 - PZ/SL x 100 1000V Insulated VDE Screwdriver		SDRPM2
PZ1 x 80 1000V Insulated VDE Screwdriver		SDRPZ1
PZ2 x 100 1000V Insulated VDE Screwdriver		SDRPZ2
SL2.5 x 75 1000V Insulated VDE Screwdriver		SDRSL2.5
SL3.5 x 100 1000V Insulated VDE Screwdriver		SDRSL3.5
SL4.0 x 100 1000V Insulated VDE Screwdriver		SDRSL4.0
SL5.5 x 100 1000V Insulated VDE Screwdriver		SDRSL5.5



Safety Guaranteed ✓
 1000V Rated 
 VDE/Gs Approved 
 IEC 60900 

Have you tried?
Our range of Twister impact rated screwdriver bit and socket sets



Great for using in an impact driver for general driving work
 See page 117



Perfect for.....
An impact rated range of smarter screwdriver bit sets & accessories



Click and Drive Adaptor

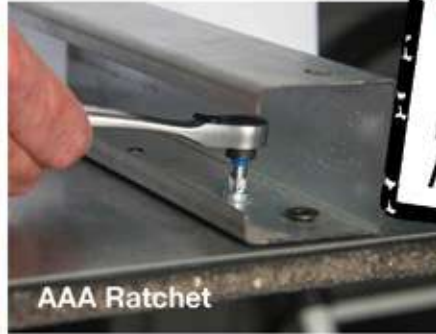

AAA Ratchet



ESD Ratchet



Impact Rated Screwdriver Bit

Armeg's time saving and problem solving screwdriver bit sets & accessories are the perfect addition to any tool kit. The range includes smarter screwdriving solutions such as the 'Click & Drive Adaptor' and 'AAA ratchet', whilst nearly all sets feature impact rated screwdriver bits for use within impact drivers. This smarter screwdriver bit range is the perfect choice for the professional tradesman.



Twister Drill Bits are



MADE IN SHEFFIELD

using a 1 piece body construction with high quality alloy steel for durability and strength

15 PIECE MASONRY FIXING INSTALLATION SET

Featuring Twister impact rated screwdriver bits and drill bits, this is the perfect set for the professional tradesman using an impact driver.

With both the Twister screwdriver bits and drill bits being designed with a 1/4" shank, the tools can be interchanged rapidly in the same power tool for the ultimate convenience.

The 15 piece set comes complete in a handy fabric roll with contents and sizes printed for easy tool identification.

TECH TIP!

Our Twister Impact Rated Masonry Drill Bits are available separately as top-up items for your set. For range details – see page 25

Twister Masonry Drill Bits (150mm)

2 x 5.5 mm

1 x 6.0 mm

1 x 7.0 mm

1 x 8.0 mm

50mm Twister Screwdriver Bits



75mm Twister Screwdriver Bits



Description	Part Number
15 Piece Masonry Fixing Installation Set	SDB&DBSET15

14 PIECE IMPACT RATED SCREWDRIVER BIT SET

The 14 Piece Set features 1/4" shank Twister impact rated screwdriver bits, perfect for direct use within impact drivers.

The bits feature a 'Torsion Portion' section which is designed with a reduced diameter. The reduced diameter allows the bits to temporarily flex under high torque loads, reducing stress at the tip and protecting from damage. This results in the bits providing up to 133% increased flex over a standard bit for extreme durability.

50mm Twister Screwdriver Bits



75mm Twister Screwdriver Bits



Description	Part Number
14 Piece Impact Rated Screwdriver Bit Set	SDBSET14T



Turn over for more Twister screwdriver bit sets



Scan me for demo video





27 PIECE SOCKET AND SCREWDRIVER BIT SET

The 27 Piece multi-purpose set features both the Armeg 'Access All Areas' ratchet and 'Click and Drive' adaptor. This provides users with both a direct drive and 90° drive option for screwdriver bits and sockets, giving extreme versatility and cost-effectiveness.

The AAA ratchet features 72 teeth which allow tightening from only 5° angle returns, making it perfect for use within tight spaces. Impact rated screwdriver bits are colour coded for easy selection.

*Please note, Sockets are not suitable for use within impact drivers

TECH TIP!

The AAA Ratchet is DIN Standard approved

FEATURING
AAA RATCHET
ACCESS ALL AREAS
& CLICK & DRIVE ADAPTOR

Sockets and 25mm Twister Screwdriver Bits



Description	Part Number
27 Piece Socket and Screwdriver Bit Set	SDB&SSET27

32 PIECE SCREWDRIVER BIT SET

The 32 Piece Screwdriver Bit set is a professional set designed with a variety of bit sizes to ensure that users always have the right bit for the right job.

The set also includes the impact rated Click and Drive Adaptor, which features a 'quick click-in' and 'quick-release' system for hassle free bit changes.

Impact rated screwdriver bits are colour coded for easy selection.

Twister 25mm Screwdriver Bits



Description	Part Number
32 Piece Screwdriver Bit Set	SDBSET32



FEATURING
CLICK & DRIVE
ADAPTOR



FEATURING
**CLICK &
DRIVE**
ADAPTOR

11 PIECE SCREWDRIVER BIT SET

The 11 Piece PZ2 multi-pack set features the most popular screwdriver bit size in a pocket-sized compact case for convenient bit accessibility.

The set includes the impact rated Click and Drive Adaptor, which features a 'quick click-in' and 'quick-release' system for hassle free bit changes.

S2 steel manufactured screwdriver bits provide excellent durability and can be used within impact drivers.



TECH TIP!

Ill-Fitting bits are prone to breakage. To prevent this make sure you:

- Use the correct bit for the application
- Take care when using bits in screws etc. with worn slots / apertures
- Ensure the bit is positively located in the screw etc. before applying torque

Description	Part Number
11 Piece PZ2 Screwdriver Bit Set	SDBSET11PZ2

21 PIECE PRECISION SCREWDRIVER BIT SET

The 21 Piece Set is designed for screwdriving applications where precision is essential and includes a range of 4mm Hex precision screwdriver bits.

Also featuring an interchangeable ESD ratchet, this set is ideal for working on electronic devices and electrostatically sensitive components. The 3 way ESD ratchet provides versatility for tightening, loosening and using as a conventional screwdriver.

*Please note this set is not suitable for use within impact drivers.

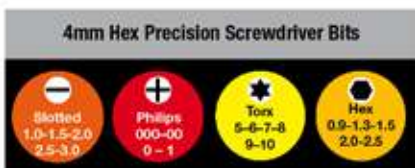

Description	Part Number
21 Piece Precision Screwdriver Bit Set	SDBSET21P



FEATURING
**INTERCHANGEABLE
ESD RATCHET**
FOR THE DELICATE DRIVE



*4mm Hex Bits (within 21 Piece Set) and Sockets (within 27 Piece Set) are not impact rated

Have you tried?
**Switch-Blade Interchangeable
VDE Screwdriving Range**



Features the VDE Interchangeable Adjustable Torque Handle for tightening to an installations required torque

See page 111



Perfect for.....

Excellent tool strength and durability when cutting wire

- A** Drop forged **Chrome Vanadium steel jaws** are induction hardened to give excellent strength and tool durability
- B** **Ergonomically designed soft grip handles provide** a comfortable and secure grip for fatigue-free use
- C** **1000V VDE rated handles** feature anti-slip guards for increased user safety



1000V VDE Diagonal Side Cutters can be used to cut:

- Soft wire
- Medium wire
- Hard wire
- Piano wire

1000V VDE Diagonal Side Cutters are ideal for:

- Cutting wire



DID YOU KNOW?

Our Side Cutters are manufactured to ISO 5749

TECH TIP!

To maximise the life of the cutting blades, try to cut at 90° to the material being cut

1000V VDE Diagonal Side Cutters

Description	Cutting Capacity				Part Number	
	Soft Wire	Medium Wire	Hard Wire	Piano Wire		
160mm VDE Diagonal Side Cutters	4.0mm	2.0mm	2.0mm	1.6mm	DDP160	
200mm VDE High Leverage Diagonal Side Cutters	5.0mm	3.5mm	2.4mm	2.0mm	DDP200	

Safety Guaranteed ✓

1000V Rated 

VDE/Gs Approved 

IEC 60900 

Have you tried?
VDE Combination Pliers



Perfect for gripping
& Cutting work

See page 123



Perfect for.....

A durable gripping surface for reliable and consistent performance

- A Drop forged Chrome Vanadium steel jaws** provide excellent tool durability; this ensures the gripping surface retains its profile in the toughest of conditions for reliable and consistent performance
- B Cutting edges are induction hardened for additional toughness**, resulting in edges which stay sharper for longer
- C Ergonomically designed soft-grip handles** provide a comfortable and secure grip for fatigue-free use
- D 1000V VDE rated handles** feature anti-slip guards for increased safety

1000V VDE Combination Pliers can be used to cut:

- Soft wire
- Medium wire
- Hard wire
- Piano wire

1000V VDE Combination Pliers are ideal for:

- Gripping, twisting & Cutting cables



Long Nose Pliers are ideal for access and more delicate gripping and cutting work

DID YOU KNOW?
Our VDE Combination Pliers are Manufactured to ISO 5746 & the Long Nose Pliers to ISO 5745

TECH TIP!
A drop of oil applied occasionally to the joint will maintain easy operation

1000V VDE Combination Pliers

Description	Max. Jaw Opening	Cutting Capacity				Part Number	
		Soft Wire	Medium Wire	Hard Wire	Piano Wire		
200mm VDE Combination Pliers	39mm	4.0mm	3.0mm	2.0mm	1.6mm	DCP200	
200mm VDE Long Nose Combination Pliers	80mm	4.0mm	3.0mm	2.0mm	1.6mm		

Safety Guaranteed ✓

1000V Rated 

VDE/Gs Approved 

IEC 60900 

Have you tried?
VDE Diagonal Side Cutters



Excellent for tool strength & durability when cutting wire

See page 121

Perfect for.....
Sharp and strong high performance
cable cutting



A Dual heat treatment process gives the optimum strength required at specific parts of the tool for excellent durability

B Extremely sharp ground cutting edge rapidly cuts through wire and cable for a clean and accurate finish

C Forged Chrome Vanadium body gives extreme strength with cutting edges that stay sharper for longer

D Milled and polished blade surfaces provide a smooth and easy to use tool

E 8" (210mm) PVC coated handles provide added grip and leverage for user comfort and ease of use

Cable Cutters can be used to cut:

- Copper Wire
- Plastic Sheathed Cable
- Aluminium Wire
- Optical Cable
- Co-axial Wire – RG58 / RG59 / RG6
- Not suitable for iron or steel wire



DID YOU KNOW?

Our Cable Cutters are manufactured to DIN ISO 5743

Cable Cutters are ideal for:

- Domestic and industrial cable installation
- TV & Satellite cable installation

TECH TIP!

When cutting try not to twist the cutter from side to side, this will prematurely dull the blades and result in an uneven cut

Cable Cutters

Description	Technical Information	Part Number	
8" (210mm) Cable Cutters - carbon steel	Capacity: 35mm ² 11mm diameter	DCC8001	

Perfect for.....

A professional range of hand tools to aid conduit installation

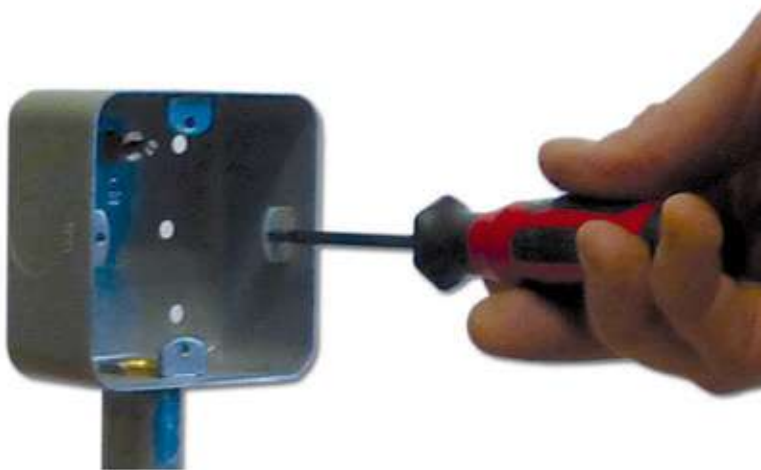

Re-Threaders



Conduit Threading Set



Re-Threaders are Ideal for:

Quickly cleans and re-threads fixing holes in socket-switch or conduit-boxes which can often be blocked by cement or plaster and have malformed threads. 3.5mm Re-Threaders are ideal for electrical back boxes in domestic house and industrial offices. 4mm Re-Threaders are perfect for use in industrial buildings

Conduit Threading Set is ideal for:

Rapidly producing accurate threads on conduit for a secure and professional installation to trunking. Set features Dies and Guides in the most popular electricians' diameters - 20 & 25mm

DID YOU KNOW?

Our CIR Range of accessories are all



TECH TIP!

Cutting Compound is recommended for use when drilling with our CIR range Pro-Step and Quick-Cone drills see page 71

CIR Range - Accessories

Description	Thread Size	Overall Length mm	Part Number
3.5mm Re-Threader - long reach	M3.5 x 0.6	135	EMWRT03.5
3.5mm Re-Threader - standard reach	M3.5 x 0.6	97	ERT03.5
4.0mm Re-Threader - standard reach	M4 x 0.7	97	ERT04.0
60cc Cutting Compound	-	-	ECC002



Description	Thread Size	Overall Length mm	Contents	Part Number
20 & 25mm Conduit Stock & Die Set	20mm = M20 x 1.5 25mm = M25 x 1.5	Double Handed Die Stock = 410	1 x Double Handed Die Stock 1 x 20mm Die 1 x 25mm Die 1 x 20mm Guide 1 x 25mm Guide	ECSDS20-25



Have you tried?
CIR Range Step & Cone Drills



Produce rapid, clean and professional large diameter holes in metal for quality conduit installation See page 71



Perfect for.....
Rapidly producing square holes
in plaster and dry lining



- A** Ergonomically designed handle combines constructional strength with soft grip touch for the ultimate user comfort experience
- B** Flared handle profile minimises chance of accidental injury by preventing hands slipping towards the sharp cutting edge
- C** 1.8mm blade construction manufactured with fully hardened, high carbon steel produces a stable sawing action and ultimate tool durability
- D** Dual ground teeth at a perfect 7 TPI ratio provides an aggressive sawing action on both the push and pull strokes for extreme speed and fast hole production
- E** 15mm straight 'punch tip' blade punches through materials prior to sawing enabling immediate cutting for a hassle free and time saving start up

EBS Board Saw can be used on:

- Plaster board
- Wood
- Plaster
- Similar materials

EBS Board Saw is ideal for:

- Cutting out square holes in plasterboard walls for electrical back boxes
- Cutting holes in plasterboard ceilings for access or downlight installation
- Cutting to size plasterboard sheets

DID YOU KNOW?

The EBS Board Saw comes with a protective blade cover for added safety and blade and tool protection

Punch

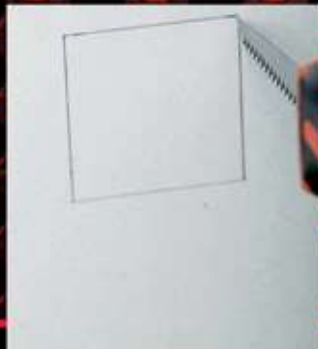

Cut



Done



EBS Board Saw

Description	TPI (Teeth Per Inch)	Overall Length mm	Part Number
EBS Board Saw - 150mm	7 TPI	150	EBSBS150



TECH TIP!

For a better finish apply more force on the push stroke rather than the pull stroke

Have you tried?
EBS - Square Hole Drills



The original square hole drill for sinking back boxes in masonry materials See page 3

Perfect for.....
An ultra-comfortable knife with quick-change blade system

- A** Soft grip TPR handle provides a non-slip surface for added safety and user comfort
- B** Quick-change system allows blades to be swiftly removed and replaced using the auto-reload mechanism, providing rapid and hassle free blade changes with no tools required
- C** Robust die-cast zinc body is designed for strength and durability with internal storage for up to 5 blades
- D** Ergonomically designed finger groove provides additional comfort, controlled cutting and helps prevent finger slippage towards the blade
- E** High-Carbon steel blade extends and retracts using an extremely smooth mechanism which also features 4 locking positions allowing different depths of cut for different applications
- F** High-Carbon SK2 steel blades are heat-treated to provide the ideal combination of sharp edges and blade toughness for great performance and durability



DID YOU KNOW?

SK2 steel blades feature a standard fitment design allowing them to be used in most standard retractable knives

The Retractable Utility Knife can be used to cut:

- Wires
- Plaster Board
- General materials

The Retractable Utility Knife is ideal for:

- Trimming
- Splicing
- General Purpose Cutting

TECH TIP!

Ensure positive location of blade in cutting position before applying pressure

Retractable Utility Knife

Description	Technical Information	Part Number	
Retractable Utility Knife (Supplied with 5 blades)	-	DRK01	
Utility Knife Blades - Pack of 5	Blade Length: 60mm Blade Thickness: 0.6mm	D5PBD	

Have you tried?
EBS Board Saw



Perfect for rapid
cutting in plaster and
dry lining

See page 129

Perfect for.....
An assured range of metal cutting saws

12" Hacksaw



- A** Lightweight aluminium frame
- B** 12" Bi-Metal hacksaw blade manufactured with M2 Steel for high durability. The shatter-proof yet flexible blade is designed with rust proof anti-corrosive paint for longer life and direction markings for hassle free sawing
- C** Dual angle blade pins which allow cutting access at awkward angles
- D** Adjustable tension screw for optimum versatility and blade performance
- E** Die cast handle for added strength

The 12" Hacksaw can be used to cut:

- Metal
- Plastic
- e.g Conduit / Trunking

The 12" Hacksaw Frame is Ideal for:

- Cutting thicker materials due to its deep throat
- Jobs where a straighter cut is required as the taller blade reduces wavering to give a straighter cut
- Applications where better grip and control are required thanks to the dual handed frame

DID YOU KNOW?

Our 12" Hacksaw Blades are manufactured to BS19:1983-ISO2336 and our 6" Junior Hacksaw Blades manufactured to BS6271 quality standards

TECH TIP!

The 12" Hacksaw Frame can be adjusted for use with 10" and 12" blades

6" Junior Hacksaw

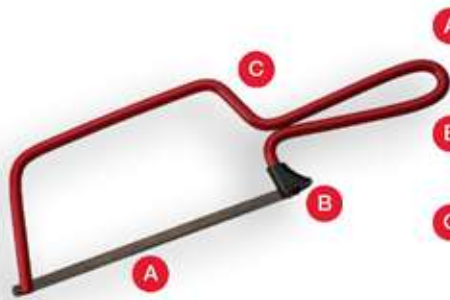

- A** Includes a 6" high carbon steel blade manufactured in the UK with 32TPI for metal cutting
- B** Rubber safety stop to prevent fingers catching on the blade
- C** Rust proof powder coated frame for longer product life

The 6" Junior Hacksaw can be used to cut:

- Metal
- Plastic
- e.g Conduit / Trunking

The 6" Junior Hacksaw is ideal for:

- Smaller / Lighter applications
- Cutting thinner materials
- Working in tight or confined spaces

6" Mini Hacksaw



- A** Adjustable tension screw for optimum versatility and blade performance
- B** Hassle free blade changes
- C** Includes a 6" high carbon steel blade manufactured in the UK with 32TPI for metal cutting





The 6" Mini Hacksaw can be used to cut:

- Metal
- Plastic
- e.g Conduit / Trunking

The 6" Mini Hacksaw is ideal for:

- Easier and hassle free blade changes
- Users who require a comfort grip hacksaw
- Working in tight or confined spaces

Hacksaws & Spare Blades

Description	Diameter mm	TPI (Teeth per inch)	Part Number	
12" Hacksaw Frame Supplied assembled with a 12" blade	12" x 1/2" x 0.025" (4mm pin hole dia)	24	HS001	
12" Hacksaw Blades - Twin Pack	12" x 1/2" x 0.025" (4mm pin hole dia)	24	HS002	
6" Junior Hacksaw Supplied assembled with a 6" blade	6"	32	HSJ002	
6" Junior Hacksaw Blades - 5 Pack	6"	32	HSJ003	
6" Mini Hacksaw Supplied assembled with a 6" blade	6"	32	HSJ004	

Have you tried?
Acceler8% Sheet Steel Holesaws



The fastest way to drill sheet steel and perfect when working with metal trunking
See page 73

Perfect for.....

A stylish and durable Tool Tote designed for professionals

- A Removable cover for flexibility and versatility.** Open lid provides easy tool access, closed lid keeps tools clean and dry
- B Square shaped waterproof base** keeps the bag upright and stable, easy to clean any oil spillages
- C Numerous internal and external pockets,** elastic tabs for screwdrivers, plus a large internal storage area, provide the ultimate in tool storage on the move
- D Padded shoulder strap** for comfort
- E Heavy duty stainless steel handle with ergonomic padded grip** makes lifting secure and comfortable
- F Made out of 1680D Polyester,** an extremely robust and durable material

Premium Hand Tool & Drill Bit Tool Kits also available





DID YOU KNOW?

All of the components in the Tool Totes are available as separate items

TECH TIP!

For a perfectly rolled cover, roll up tightly with the silver side exposed, and apply to Velcro straps

Tool Totes & Kits

Description	Contents	Part Number		
18" Tool Tote	-	DHTBAG001		
8 Piece Hand Tool Kit	1 x 18" Tool Tote 1 x 160mm VDE Diagonal Side Cutters 1 x 200mm VDE High Leverage Diagonal Side Cutters 1 x 200mm VDE Combination Pliers 1 x 200mm VDE Long Nose Combination Pliers 1 x 5m Tape Measure 1 x 16oz Claw Hammer 1 x Retractable Utility Knife 1 x Utility Knife Blades - 5 pack		DHTB001	
20 Piece Premium Drilling Kit	1 x 18" Tool Tote Acceler8% Sheet Steel Holesaw 1 x 20mm Nail-Proof WoodBeaver 1 x 20mm 1 x 25mm CVP – Cobalt Vari-Pitch Holesaw 1 x 25mm 1 x 9.5mm Hexagon Shank Drive Arbor QFDS SDS Plus Hammer Drill Bits 2 x 5.5mm x 160mm 1 x 6.0mm x 160mm 1 x 7.0mm x 160mm 1 x 8.0mm x 160mm Twister Impact Rated 1/4" Hex Masonry Drill Bits 2 x 5.5mm x 150mm 2 x 6.0mm x 150mm HSS Flute Ground 135° Split Point Drill Bits 2 x 3.0mm 2 x 4.0mm 2 x 6.0mm		DDBB001	

Have you tried?
EBS Board Saw



Perfect for rapid cutting in plaster and dry lining

See page 129



Perfect for.....
Excellent strength and durability

- A One Piece, forged chrome vanadium construction** for excellent strength and durability
- B Slip-resistant soft grip handle** for user comfort
- C Ground, polished and lacquered** to provide anti-rust protection
- D Anti-vibration grip handle** with shock-absorbing properties for comfort and control

DID YOU KNOW?

The claw hammer was invented in 1840

The 16oz Claw Hammer is ideal for:

- Driving and extracting nails
- General hammering work

16oz Claw Hammer

Description	Technical Information	Part Number	
16oz Claw Hammer	16oz	DCH01	

Have you tried?
8 Piece Hand Tool Kit



Premium Hand Tools
in a durable Tool Tote
See page 136

Perfect for.....

Nylon coated steel tape for durability

- A Nylon coated steel tape** provides protection from abrasive wear for increased durability, whilst the non-reflective finish allows for easy readability
- B Soft grip finish** provides users with a strong, secure and comfortable grip
- C 90° floating hook** allows the accurate measure of internal and external diameters
- D Sliding lock mechanism** provides a fast and secure system for locking measurement readings in place
- E Tape measure case is constructed from ABS shock-absorbent plastic** allowing it to withstand impacts for site-assured quality



DID YOU KNOW?

Our tape measure features a metal belt clip for on-site accessibility

TECH TIP!

Place hook end against a wall for an inside measurement, or hook it on an edge for an outside measurement. The movement of the hook takes the thickness of the hook end into consideration, providing an accurate measure

5m / 16' Tape Measure

Description	Technical Information	Part Number
5m / 16' Tape Measure	5m x 19mm EC Class II Standout Length - 1.7m	DTM5M





Perfect for.....
The quick and simple way to run a line

**Simply fix the clamps,
 run the line and lay your course**

- A Spring loaded adjustable jaws** provide a sturdy clamping solution with an easy one handed operation
- B Tough PPR Material and box section construction** for extreme durability
- C Jaws are stable and secure** for robust performance

- Brick Line Runner can be used on:**
- Bricks and blocks approximately 95 – 125mm
 - Most smooth or raked bricks / blocks

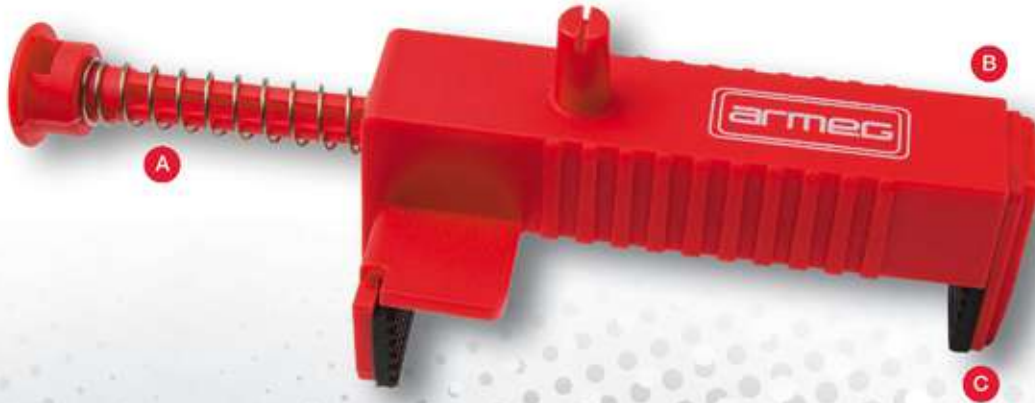

DID YOU KNOW?

The Brick Line Runner was designed by professional brick layers in conjunction with our development team, working together on active building sites

TECH TIP!

Try using multiple clamps for working around corners and on multiple walls

Brick Line Runner is ideal for:

- Simultaneous work on multiple walls
- Working on internal corners
- Maximising time efficiency
- Applications where it is ideal to avoid using line pins
- Aiding gable end construction
- Working on splayed bays

Scan me for demo video



Brick Line Runner

Description	Technical Information	Part Number	
Brick Line Runner - Twin Pack	Each pack contains 2 Clamps and 10m Brick Line	ABLR001	



Clamp it
for no dropped
corner blocks



Clamp it
for no requirement to
maintain perfect tension
when setting up



Clamp it
for simultaneous work
on multiple walls



Clamp it
for work on internal
corners

Perfect for.....**An innovative collection of smart design wrenches that solve common installation issues**

The Jaw Dropper's adjustable jaws allow users to work on both the pipe union nut and the tap back nut with the same wrench

In the closed position the bottom half of the jaw acts as a stop when tightening / removing the union nut

When the sliding jaw is dropped, the tap back nut can be tightened without having to turn off the water supply or drain the system. The Jaw Dropper's slim design ensures maximum accessibility

Ideal for:

- Tightening taps without isolating the water supply

Great for use on:

- Different jaws at either end of the wrench cover a wide range of nut sizes

**DID YOU KNOW?**

The Jaw Dropper is an original Armeg design that was prototyped, designed and tested at our Sheffield HQ

TECH TIP!

Make sure you are using the correct end of the wrench for your particular application. It should be a snug fit on the fitting being worked on. If it is a loose fit with too much movement then the other end of the wrench should be tried

Scan me for demo video



GRIPFAST 



Available in three different sizes, Grip Fast is the latest innovation in water pump pliers. They automatically adjust to the required size with only having to use one hand.

The patented system allows for faster safer work in confined areas without losing any of the benefits of traditional styles. Grip Fast features wide opening gripping jaws with easy grip handles and a spring resistance to automatically adjust to the gripping width

Ideal for:

- One handed water pump pliers which automatically adjust to any size

Great for use on:

- Plumbing, mechanical, electrical and general work



Turn over for more innovation wrenches

Scan me for demo video



Waste Pipe Chamfering Tool



This innovative tool can quickly and easily remove burr and chamfer waste pipes on both the inside and outside of the pipe

The outside burr is removed and the pipe chamfered by placing the pipe end against the blade and rotating, steadying the pipe with the pins. The inside burr is removed using the tools handle



Ideal for:

- Chamfering waste pipes in seconds

Great for use on:

- Plastic waste pipes sizes 32 to 41mm (1-1/4" & 1-1/2")

Scan me for demo video



Soil Pipe Chamfering Tool



Driven off an adaptor in a power tool, the Soil Pipe Chamfering Tool is designed to remove the burr from around soil pipes to prevent seals being pushed out of fittings when assembled. The carbide grit section chamfers your pipe in seconds and also provides excellent tool durability

Ideal for:

- Chamfering soil pipes in seconds

Great for use on:

- Plastic soil pipes – standard pipe size 110mm











Scan me for demo video



TECH TIP!

The pipe being chamfered should be held firmly in a vice or similar. The tool can then be rotated by the power tool around the cut edge of the pipe to remove the burr

Wrenches

Description	Technical Product Detail	Part Number	
Jaw Dropper Access Wrench	Set Contains 1 x Basin Wrench, 1 x Bath Wrench, 1 x Slotted Screwdriver (for jaw adjustment)	DSPSETJD1	
Pipe Chamfering Tool - Waste Pipes	Suitable for 32 - 41mm waste pipes	DSPSDPCT	
Pipe Chamfering Tool - Soil Pipes	Suitable for 110mm soil pipes	DSPLDPCT	
Drive Adaptor for Soil Pipe PCT - Hexagon shank	5/8" - 18 UNF Thread	DSPLDHEX	
Drive Adaptor for Soil Pipe PCT - SDS Plus shank	5/8" - 18 UNF Thread	DSPLDSDS	
Grip-Fast Water Pump Pliers - 7"	Jaw Opening - 35mm Max. Capacity for pipes - 32mm Max. Capacity for nuts - 30mm	DGF07WPP	
Grip-Fast Water Pump Pliers - 10"	Jaw Opening - 50mm Max. Capacity for pipes - 40mm Max. Capacity for nuts - 38mm	DGF10WPP	
Grip-Fast Water Pump Pliers - 12"	Jaw Opening - 55mm Max. Capacity for pipes - 50mm Max. Capacity for nuts - 46mm	DGF12WPP	

*The Jaw Dropper is designed for 1/2" and 3/4" BSP threads – suitability with every manufacturers nut size cannot be guaranteed.



13mm Soil Pipe Chamfering Tool
(When used with adaptor DSPLDHEX)



Soil Pipe Chamfering Tool
(When used with adaptor DSPLDSDS)



Jaw Dropper is designed for use with 1/2" & 3/4" BSP threads



Soil Pipe Adaptors - Hex & SDS Adaptors
5/8" - 18 UNF

Perfect for.....
Removing broken bolts and screws



- A Square Shank**
 Square shank is designed for use with spanners etc for user convenience
- B Job-Specific Steel**
 Manufactured with a job-specific grade of steel designed to withstand flex and high torque loads experienced during operation.
- C Left Hand Thread**
 Left hand thread allows Screw Extractors to be inserted into broken screws or studs and turned anti-clockwise to extract

Screw Extractors are ideal for extracting:

- Broken screws
- Broken bolts
- Broken studs
- Rounded off screw heads



DID YOU KNOW?

Screw Extractors are
 **MADE IN SHEFFIELD**

TECH TIP!

When using Screw Extractors, first drill a pilot hole in the screw to be extracted to the correct diameter required. The Screw Extractor can then be placed into the pilot hole and turned anti-clockwise to extract the screw

TECH TIP!



Be careful not to over-exert the screw extractor when attempting to turn the broken screw (especially on the small diameters). Over-exertion could cause breakage

Screw Extractors

Description	Pre-Drill with HSS diameter mm	Part Number
Number 1	Please see technical information chart	NO.1 SCREW
Number 2		NO.2 SCREW
Number 3		NO.3 SCREW
Number 4		NO.4 SCREW
Number 5		NO.5 SCREW
Number 6		NO.6 SCREW
Number 7		NO.7 SCREW
Number 8		NO.8 SCREW
Number 9		NO.9 SCREW



Description	Part Number
5 Piece Set A (Numbers 1 - 5)	SET A
6 Piece Set B (Numbers 1 - 6)	SET B

No.	Size of screw to be removed (mm)	Size of screw to be removed (imperial)	Low / Medium tensile screws		High tensile screws		Drive Square
			Pre-drilled hole size (mm)	Pre-drilled hole size (imperial)	Pre-drilled hole size (mm)	Pre-drilled hole size (imperial)	
1	3 - 5	1/8" - 3/16"	2	5/64"	2	5/64"	3.15
2	6	1/4"	2.8	7/64"	3	1/8"	4
3	8 - 10	5/16" - 3/8"	4	5/32"	4.3	11/64"	5
4	12	7/16"	5.5	7/32"	6	15/64"	6.3
5	14	1/2" - 9/16"	7.2	9/32"	8	5/16"	9
6	16 - 20	5/8" - 3/4"	10.5	13/32"	11	7/16"	11.2
7	22 - 30	7/8" - 1"	13.5	17/32"	14.5	9/16"	14
8	33 - 42	1.3/8"	20.5	13/16"	21.5	27/32"	20
9	45	1.3/4"	27	1.1/16"	28	1.3/32"	25



Perfect for.....
Driving Sockets, Screwdriver Bits and
3 Jaw Chucks in to SDS Plus Machines





HB4CHTSC



HB4SOC

SDS Plus Chuck Adaptors & Socket Drivers

Description	Technical Information	Part Number	
SDS Plus to Internal Thread Chuck Adaptor	1/2" U.N.F external thread for attaching 3-jaw chucks M6x1 left hand thread hole designed to accept a countersunk screw for securely attaching chucks	HB4CHTSC	
SDS Plus to 1/2" Socket Driver	Square connection for driving 1/2" square drive sockets	HB4SOC	

DID YOU KNOW?

Our range of SDS Plus Chuck Adaptors & Socket Drivers are all



TECH TIP!

When driving sockets & screwdriver bits be sure to disengage the impact function of the power tool

Have you tried?
Our range of Screwdriver Bit & Socket Sets



A great range of time-saving and problem-solving Screwdriver Bit Sets

See page 117

TECHNICAL ICONS

These icons will appear throughout our catalogue to provide you with technical information and usage recommendations for our products.



Spanner size required



Use in portable drilling machine



Use in fixed drilling machine



Cutting Lubricant recommended



Allen Key size



Use in power tools with a 3 jaw chuck



Use in SDS Max power tools



Use in SDS Plus power tools



Screw thread dimension



1/4" quick-change shank



Instruction



Hexagon dimension



Minimum power tool wattage recommended



Use in angle grinder



Use in wall chasing machine



K Taper shank / receptacle



Water should be used to cool



Use on rotary only



Impact rated for impact drivers

armeg ™



Wholesaler Contact Details

ISSUE 2

THINK SMART  PERFORM SMART  TRUST ARMEG



Armeg Ltd. Callywhite Lane, Dronfield, S18 2XJ
Tel: +44 (0) 1246 411 081 Fax: +44 (0) 1246 411 882
Email: sales@armeg.co.uk

www.armeg.com

Need a product urgently?

CALL US: +65 6294 6388

EMAIL: cmltc@singnet.com.sg

VISIT US: 75 Rowell Road, Singapore 208011

OPENING HOURS: Monday-Friday, 9.00AM – 5.30PM

Why choose Chan Man Lee?

- ✓ Ready stock of 25,000 products
- ✓ No MOQ required for majority of our products
- ✓ Product pickup ready in 10 minutes~1 working day
- ✓ Certified/authorised distributor for over 30 brands
- ✓ Only supplies products from well-known, esteemed brands
- ✓ Only genuine, authentic, factory-original products
- ✓ Technical knowledge on product codes (IMPA, sizing, etc.)